

Gas Discharge Tube: G12D8A Series *α Therm*

2-Electrode $\Phi 11.8 \times T8$ mm Type

■ Features

1. RoHS & HF compliant
2. Rugged ceramic-metal construction
3. DC spark-over voltage: 230~800V
4. Follow current at 50/60Hz: 50~100A (For 300~800V)
5. Max continuous operating voltage at 50/60Hz: 95~255V (For 230~800V)
6. Operating temperature: $-40^{\circ}\text{C} \sim +85^{\circ}\text{C}$
Storage temperature: $-40^{\circ}\text{C} \sim +115^{\circ}\text{C}$

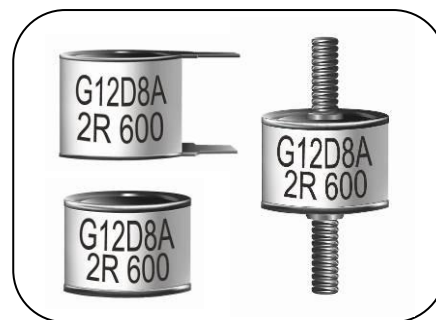

■ Recommended Applications

1. Power system
2. Industrial equipment
3. SPD module

■ Part Number Code

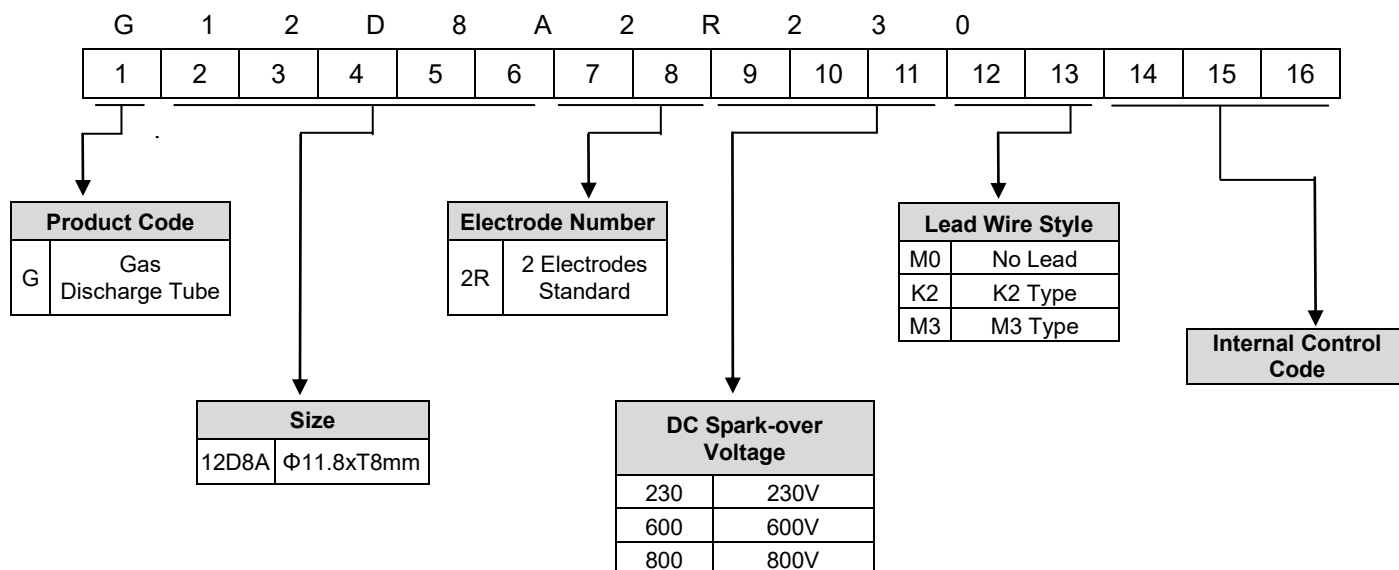

Gas Discharge Tube: G12D8A Series *Alpha Therm*

2-Electrode $\Phi 11.8 \times T8$ mm Type

■ Characteristics

Part No.	DC Spark-over Voltage	Max. Impulse Breakdown Voltage	Max. Impulse Discharge Current (8/20 μ s)		Impulse Life (10/1000 μ s)	Normal Alternating Discharge Current	Maximum Impulse Breakdown Voltage	Follow Current	Max Continuous Operating Voltage	Minimum Insulation Resistance	Maximum Breakdown Time	Safety Approvals
	100V/S	1KV/ μ s	1 time	10 times	300A	50Hz, 1Sec	1.2/50 μ s 6KV	50/60Hz	50/60Hz	(G Ω)	(ns)	UL 1449/cUL
	(V)	(V)	(KA)		(times)	(A)	(V)	(A)	(V)			
G12D8A2R230□□	184-276	700	40	20	300	40	1100	/	95	1	100	✓
G12D8A2R250□□	200-300	700					1100	/	95			✓
G12D8A2R300□□	240-360	800					1100	50	130			✓
G12D8A2R350□□	280-420	800					1100	50	150			✓
G12D8A2R420□□	336-504	800					1200	50	175			✓
G12D8A2R470□□	376-564	1000					1300	100	220			✓
G12D8A2R600□□	480-720	1200					1400	100	255			✓
G12D8A2R700□□	560-840	1300					1500	100	255			✓
G12D8A2R800□□	640-960	1400					1500	100	255			✓

Note 1: The □□ is the style of lead wire.

Note 2: UL 1449 4th File No: E314979.

Note 3: Insulation resistance test conditions:

DC Spark-over Voltage	DC Measuring Voltage
230-350V	100V
420-800V	250V

■ Dimensions

(Unit: mm)

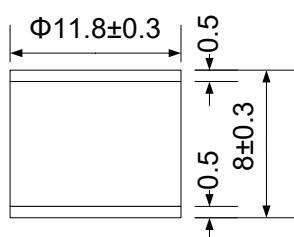

Figure 1

M0: No Lead

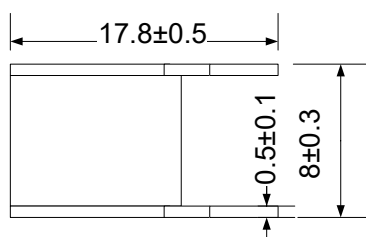

Figure 2

K2: K2 Type

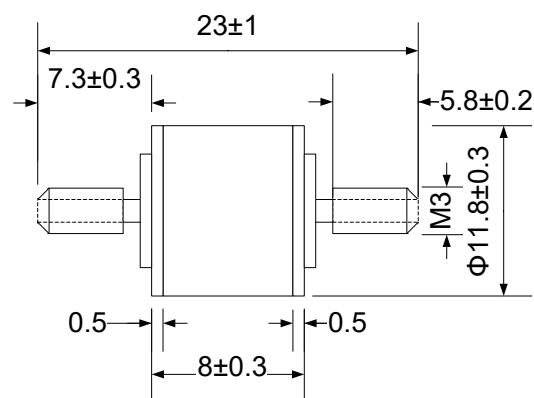
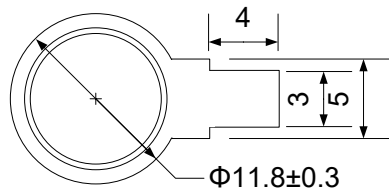

Figure 3

M3: M3 Type



Note: tolerance of 3,4,5 is ± 0.2 mm

Gas Discharge Tube: G12D8A Series *α Therm*

2-Electrode $\Phi 11.8 \times T8$ mm Type

■ Marking

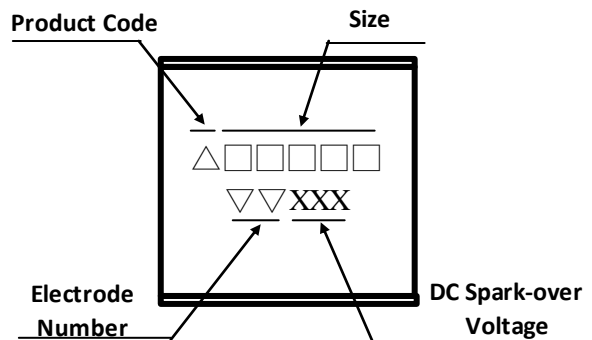

Example

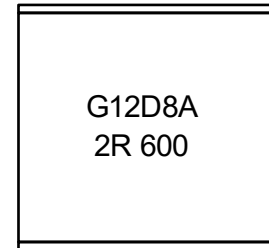

■ Packaging

- Bulk

■ Warehouse Storage Conditions of Products

- Storage Conditions:
 1. Storage Temperature: $-10^{\circ}\text{C} \sim +40^{\circ}\text{C}$
 2. Relative Humidity: $\leq 75\% \text{RH}$
 3. Keep away from corrosive atmosphere and sunlight.
- Period of Storage: 1 year