

SPECIFICATIONS

MECHANICAL LIFE: 40,000 make-and-break cycles.

CONTACT RATING: 0.4 VA max. @ 20 V AC or DC max.

CONTACT RESISTANCE: Below 100 mΩ typ. initial @ 2-4 V DC, 100 mA.

INSULATION RESISTANCE: 500 MΩ min.

DIELECTRIC STRENGTH: 500 Vrms min. @ sea level.

OPERATING TEMPERATURE: -30°C to 85°C

MATERIALS

HOUSING AND BASE: Glass filled nylon 6/6 or 4/6, flame retardant, heat stabilized (UL94V-0)

ACTUATOR: Glass filled nylon 6/6, flame retardant, heat stabilized (UL94V-0), with standard internal o-ring seal.

SWITCH SUPPORT: Steel, with Sn plate.

CONTACT / TERMINALS: Gold plated Copper alloy.

IP 67
ACCORDING TO
EN 60529:1991+A1:2001
IEC 60529:2001





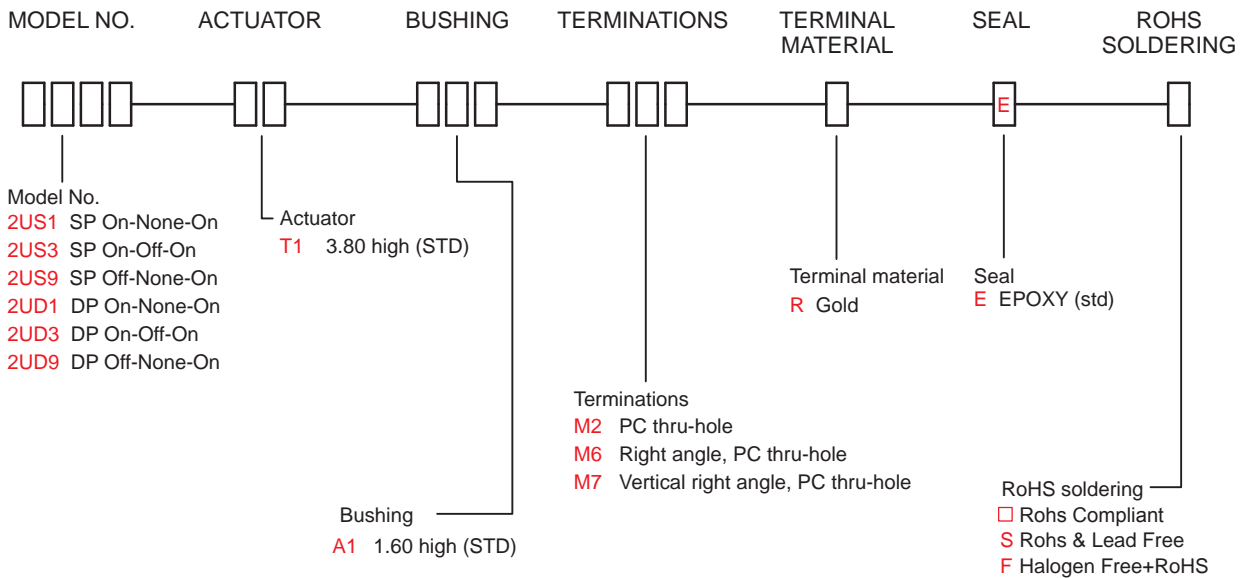

2U
Toggle Switches

HOW TO ORDER

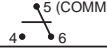
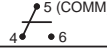

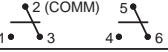
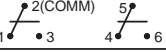
SWITCH FUNCTION

NO. POLES	MODEL NO.	SWITCH FUNCTION			CONNECTED TERMINALS / SCHEMATIC		
		POS.1	POS.2	POS.3	POS.1	POS.2	POS.3
SP	2US1	ON	NONE	ON	5-6	N/A	5-4
	2US3	ON	OFF	ON		OPEN	
	2US9	OFF	NONE	ON	OPEN	N/A	4-6 
DP	2UD1	ON	NONE	ON	2-3,5-6	N/A	2-1,5-4
	2UD3	ON	OFF	ON		OPEN	
	2UD9	OFF	NONE	ON	OPEN	N/A	

MOM=MENTORY

POLE OPTIONS

M2

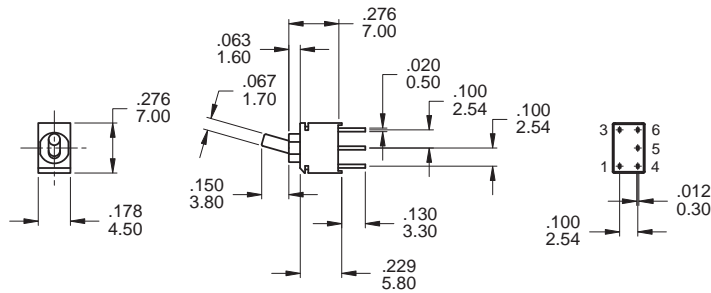

P.C. MOUNTING

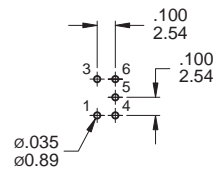

SPDT

Part No. Shown : 2US1T1A1M2RE

M2

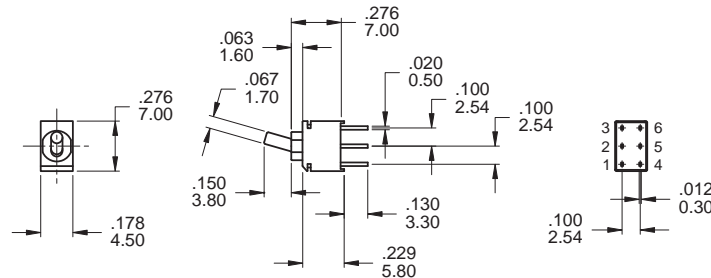

P.C. MOUNTING

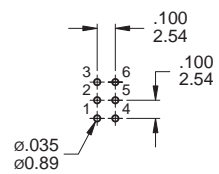

DPDT

Part No. Shown : 2UD1T1A1M2RE

MZ

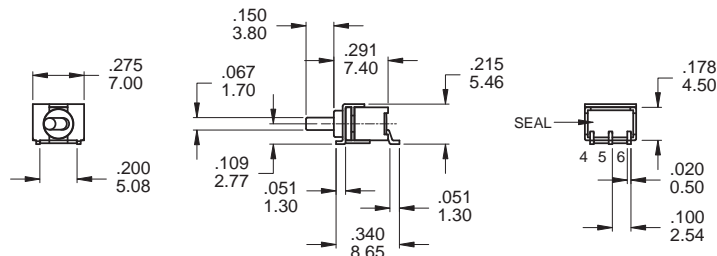

P.C. MOUNTING

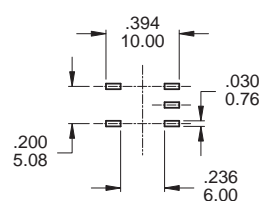

SPDT

Part No. Shown : 2US1T1A1MZRE

M6

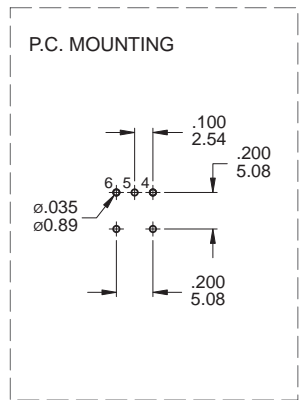
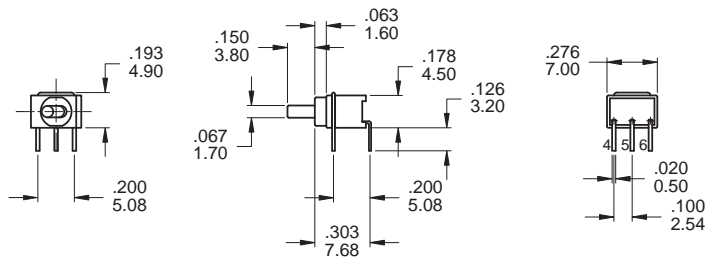

SPDT

Part No. Shown : 2US1T1A1M6RE

M6

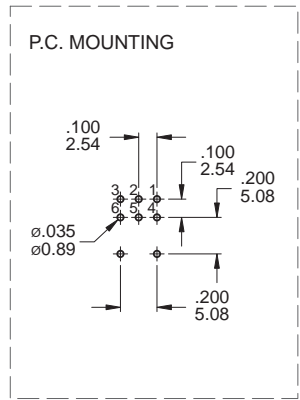
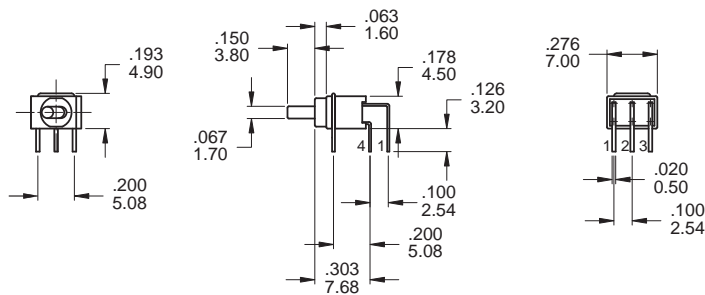

DPDT

Part No. Shown : 2UD1T1A1M6RE

M7

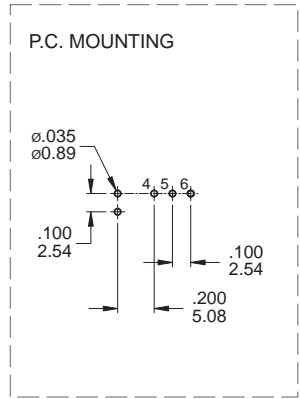
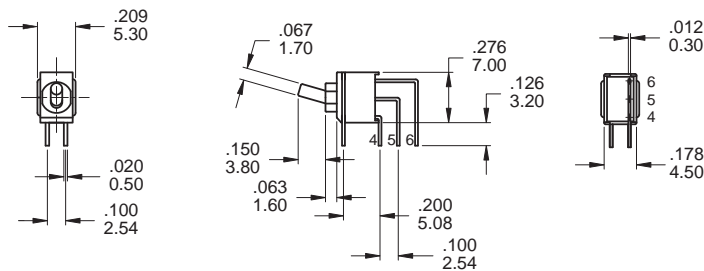
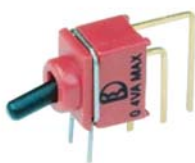

SPDT

Part No. Shown : 2US1T1A1M7RE

M7

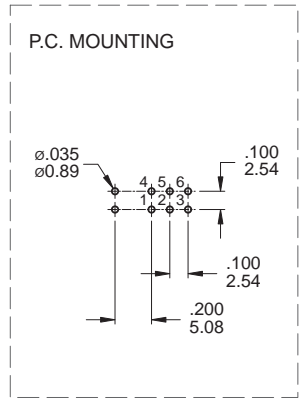
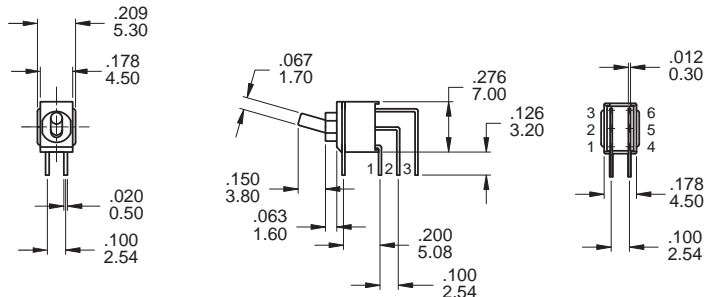
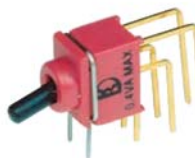

DPDT

Part No. Shown : 2UD1T1A1M7RE



SOLDERING PROCESSES

WAVE SOLDERING: Recommended Soldering Temperature: $260 \pm 5^\circ\text{C}$
 Duration of Solder Immersion: Max 5 sec.
 (PCB is 1.6mm in thickness)

SOLDERING: Vapor phase

2U
Sealed Ultraminiature Toggle Switches

