

# Metal Oxide Varistor : TVR-D Series

## Disc Type Varistor for Surge Protection (High Surge Series)

### ■ Features

1. RoHS compliant
2. Halogen-free series are available
3. Body size:  $\Phi 7\text{mm} \sim \Phi 20\text{mm}$
4. Wide operating voltage range: 115Vac ~ 680Vac
5. High surge current rating up to 13KA
6. High energy rating up to 720 Joule
7. Operating temperature range:  $-40^{\circ}\text{C} \sim +85^{\circ}\text{C}$   
Storage temperature range:  $-40^{\circ}\text{C} \sim +125^{\circ}\text{C}$
8. Agency recognition: UL 1449 3<sup>rd</sup>/cUL/VDE/CQC
9. TVR10-D, 14-D, and 20-D meet IEC60950-1:2013 Annex Q requirement
10. TVR20-D series for SPD Type 2 is available

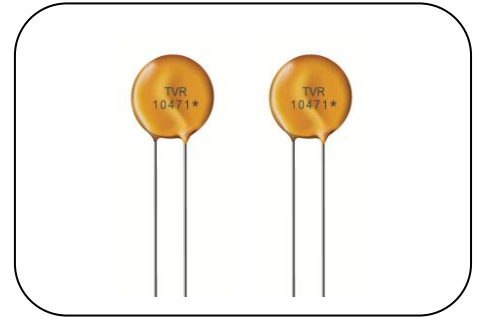

Note: \* of the marking stands for TVR-D series

### ■ Recommended Applications

1. Power supply
2. Home appliance
3. Industrial equipment
4. Telecommunication or telephone system
5. Smart meter
6. PLC (Power line communication)
7. Lighting products
8. Photovoltaic industry

### ■ Part Number Code

$\Phi 7\text{mm} \sim \Phi 20\text{mm}$

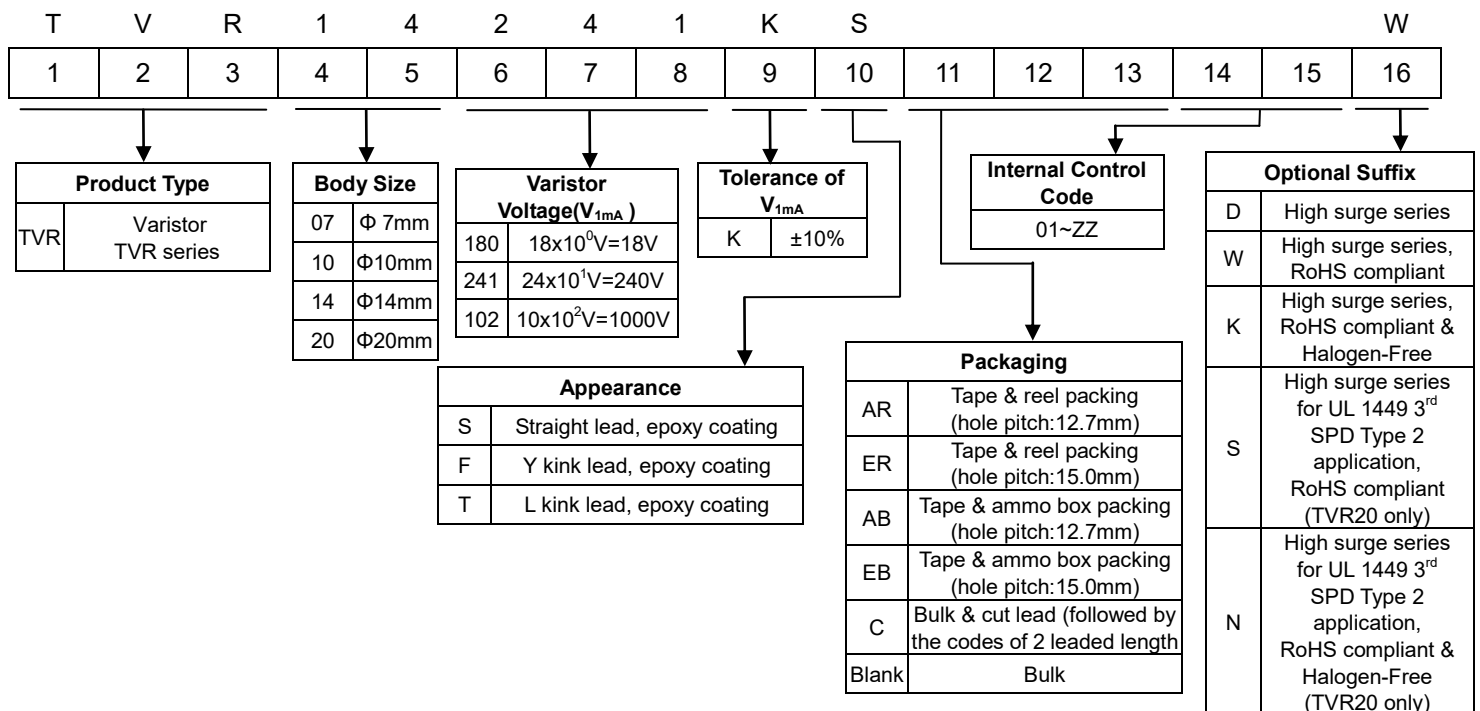

Note: Optional suffix will be the 11<sup>th</sup> digit if packaging and internal control codes are not coded.

# Metal Oxide Varistor : TVR-D Series

## Disc Type Varistor for Surge Protection (High Surge Series)

### Structures and Dimensions

- S Type (Straight lead)

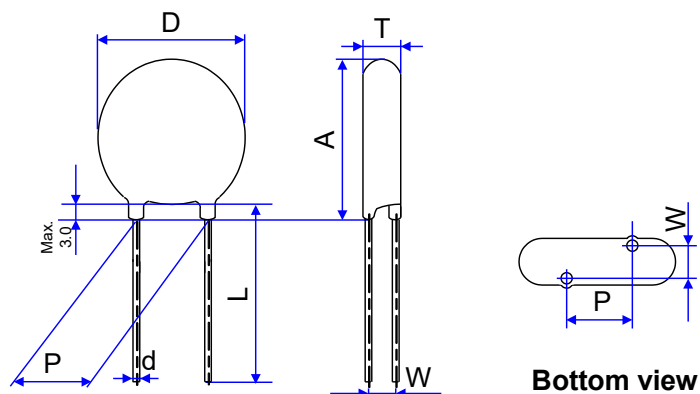

(Unit: mm)

Series	D	Lmin.	d	P	Amax.	Tmax.	W
TVR07-D	7.5~9.5	26.5	0.6±0.02	5±1	12.5	Please refer to Electrical Characteristics Table	
TVR10-D	12.0~14.0	26.5	0.8±0.02	7.5±1	17.5		
TVR14-D	16.0~18.5	26.5	0.8±0.02	7.5±1	21.5		
TVR20-D	22~24.5	22.5	1.0±0.02	10±1	28.5		

- F Type (Y kink lead)

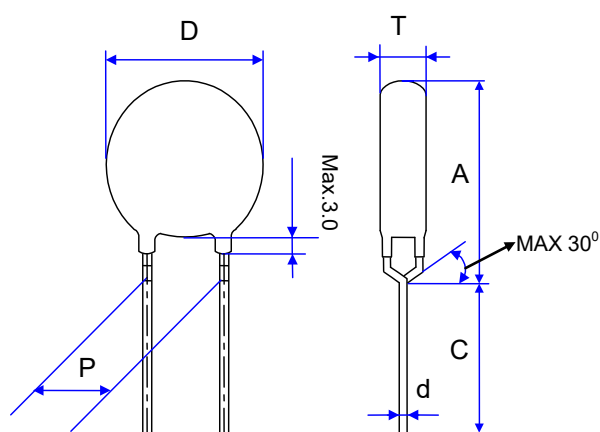

(Unit: mm)

Series	D	Cmin.	d	P	Amax.	Tmax.	W
TVR07-D	7.5~9.5	20	0.6±0.02	5±1	12.5	Please refer to Electrical Characteristics Table	
TVR10-D	12.0~14.0	20	0.8±0.02	7.5±1	18.0		
TVR14-D	16.0~18.5	20	0.8±0.02	7.5±1	22.0		
TVR20-D	22~24.5	20	1.0±0.02	10±1	29.0		

## Disc Type Varistor for Surge Protection (High Surge Series)

- T Type (L kink lead)

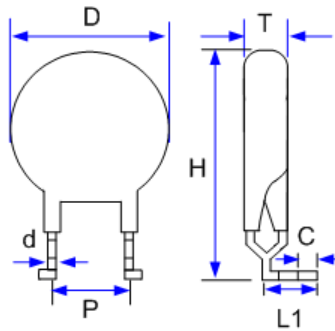

(Unit: mm)

Series	D	C	d	P	Hmax.	L1	Tmax.
TVR10-D	12.0~14.0	3.8±0.8	0.8±0.02	7.5±1	22.0	7.0±1	Please refer to Electrical Characteristics Table
TVR14-D	16.0~18.5		0.8±0.02	7.5±1	26.5	7.0±1	
TVR20-D	22.0~24.5		1.0±0.02	10±1	33.0	9.0±1	

# Metal Oxide Varistor : TVR-D Series

## Disc Type Varistor for Surge Protection (High Surge Series)

### ■ Electrical Characteristics

#### 07-D Series

Certified Model No.	Part No.	Varistor Voltage (@ 1mA DC)	Max. Continuous Voltage			Max. Clamping Voltage (8/20µs)		Max. Surge Current (8/20µs)	Rated Power	Max. Energy (10/1000µs)	Reference Capacitance @1KHz	Dimension			UL 1449 3 <sup>rd</sup> SPD Application				
			V <sub>1mA</sub>	V <sub>AC(rms)</sub>	V <sub>DC</sub>	V <sub>P</sub>	I <sub>P</sub>					I <sub>max</sub>	P	W <sub>max</sub>		C <sub>p</sub>	T <sub>min</sub>	T <sub>max</sub>	W ±1.0
TVR07181-D	TVR07181KSW	180 (162~198)	115	150	300	10	1800	0.25	19	255	2.0	3.9	1.4	For Other Application					
TVR07201-D	TVR07201KSW	200 (180~220)	130	170	340	10	1800	0.25	21	230	2.1	4.0	1.5						
TVR07221-D	TVR07221KSW	220 (198~242)	140	180	360	10	1800	0.25	23	210	2.1	4.0	1.5						
TVR07241-D	TVR07241KSW	240(216~264)	150	200	395	10	1800	0.25	25	195	2.3	4.2	1.6						
TVR07271-D	TVR07271KSW	270 (243~297)	175	225	455	10	1800	0.25	28	175	2.4	4.4	1.7						
TVR07301-D	TVR07301KSW	300 (270~330)	195	250	500	10	1800	0.25	32	155	2.7	4.4	1.9						
TVR07331-D	TVR07331KSW	330 (297~363)	215	275	550	10	1800	0.25	34	140	2.8	4.5	2.0						
TVR07361-D	TVR07361KSW	360 (324~396)	230	300	595	10	1800	0.25	37	130	2.9	4.6	2.1						
TVR07391-D	TVR07391KSW	390 (351~429)	250	320	650	10	1800	0.25	40	120	3.1	4.8	2.3						
TVR07431-D	TVR07431KSW	430 (387~473)	275	350	710	10	1800	0.25	46	100	3.0	5.1	2.3						
TVR07471-D	TVR07471KSW	470 (423~517)	300	385	775	10	1800	0.25	49	90	3.2	5.2	2.4						
TVR07511-D	TVR07511KSW	510 (459~561)	320	410	845	10	1800	0.25	54	85	3.4	5.4	2.6						
TVR07561-D	TVR07561KSW	560 (504~616)	350	450	930	10	1800	0.25	55	80	3.6	5.5	2.8						
TVR07621-D	TVR07621KSW	620 (558~682)	395	510	1020	10	1800	0.25	59	80	3.9	5.9	3.0						
TVR07681-D	TVR07681KSW	680 (612~748)	420	560	1120	10	1800	0.25	62	75	4.1	6.2	3.2						
TVR07751-D	TVR07751KSW	750 (675~825)	465	615	1235	10	1800	0.25	66	70	4.4	6.4	3.5						
TVR07821-D	TVR07821KSW	820 (738~902)	510	670	1355	10	1800	0.25	71	65	4.5	6.4	3.2						

# Metal Oxide Varistor : TVR-D Series

## Disc Type Varistor for Surge Protection (High Surge Series)

### 10-D Series

Certified Model No.	Part No.	Varistor Voltage (@ 1mA DC)	Max. Continuous Voltage		Max. Clamping Voltage (8/20µs)		Max. Surge Current (8/20µs)	Rated Power	Max. Energy (10/1000µs)	Reference Capacitance @1KHz	Dimension			UL 1449 3 <sup>rd</sup> SPD Application
		V <sub>1mA</sub>	V <sub>AC(rms)</sub>	V <sub>DC</sub>	V <sub>P</sub>	I <sub>P</sub>	I <sub>max</sub>	P	W <sub>max</sub>	C <sub>p</sub>	T <sub>min</sub>	T <sub>max</sub>	W ±1.0	
		(V)	(V)	(V)	(V)	(A)	(A)	(W)	(J)	(pF)	(mm)			
TVR10181-D	TVR10181KSW	180 (162~198)	115	150	300	25	4000	0.4	47	570	2.4	4.3	1.6	For Other Application
TVR10201-D	TVR10201KSW	200 (180~220)	130	170	340	25	4000	0.4	52	520	2.5	4.4	1.7	For SPD Type 3 Application
TVR10221-D	TVR10221KSW	220 (198~242)	140	180	360	25	4000	0.4	58	470	2.5	4.4	1.7	
TVR10241-D	TVR10241KSW	240 (216~264)	150	200	395	25	4000	0.4	64	420	2.7	4.6	1.8	
TVR10271-D	TVR10271KSW	270 (243~297)	175	225	455	25	4000	0.4	67	370	2.8	4.8	1.9	
TVR10301-D	TVR10301KSW	300 (270~330)	195	250	500	25	4000	0.4	70	340	3.1	4.8	2.1	
TVR10331-D	TVR10331KSW	330 (297~363)	215	275	550	25	4000	0.4	72	320	3.2	4.9	2.2	
TVR10361-D	TVR10361KSW	360 (324~396)	230	300	595	25	4000	0.4	76	300	3.3	5.0	2.3	
TVR10391-D	TVR10391KSW	390 (351~429)	250	320	650	25	4000	0.4	82	280	3.5	5.2	2.5	
TVR10431-D	TVR10431KSW	430 (387~473)	275	350	710	25	4000	0.4	93	250	3.4	5.5	2.5	
TVR10471-D	TVR10471KSW	470 (423~517)	300	385	775	25	4000	0.4	99	240	3.6	5.6	2.6	
TVR10511-D	TVR10511KSW	510 (459~561)	320	410	845	25	4000	0.4	107	220	3.8	5.8	2.8	
TVR10561-D	TVR10561KSW	560 (504~616)	350	450	930	25	4000	0.4	113	200	4.0	5.9	3.0	
TVR10621-D	TVR10621KSW	620 (558~682)	395	510	1020	25	4000	0.4	125	190	4.3	6.3	3.2	
TVR10681-D	TVR10681KSW	680 (612~748)	420	560	1120	25	4000	0.4	128	180	4.9	6.6	3.4	
TVR10751-D	TVR10751KSW	750 (675~825)	465	615	1235	25	4000	0.4	134	170	4.9	6.8	3.7	
TVR10821-D	TVR10821KSW	820 (738~902)	510	670	1355	25	4000	0.4	146	140	4.9	6.8	3.4	
TVR10911-D	TVR10911KSW	910 (819~1001)	550	745	1500	25	4000	0.4	152	130	5.3	7.2	3.7	
TVR10102-D	TVR10102KSW	1000(900~1100)	625	825	1650	25	4000	0.4	170	120	5.5	7.5	4.0	
TVR10112-D	TVR10112KSW	1100(990~1210)	680	895	1815	25	4000	0.4	180	110	5.7	8.0	4.3	

# Metal Oxide Varistor : TVR-D Series

## Disc Type Varistor for Surge Protection (High Surge Series)

### 14-D Series

Certified Model No.	Part No.	Varistor Voltage (@ 1mA DC)	Max. Continuous Voltage		Max. Clamping Voltage (8/20µs)		Max. Surge Current (8/20µs)	Rated Power	Max. Energy (10/1000µs)	Reference Capacitance @1KHz	Dimension			UL 1449 3 <sup>rd</sup> SPD Application
		V <sub>1mA</sub>	V <sub>AC(ms)</sub>	V <sub>DC</sub>	V <sub>P</sub>	I <sub>P</sub>	I <sub>max</sub>	P	W <sub>max</sub>	C <sub>p</sub>	T <sub>min</sub>	T <sub>max</sub>	W ±1.0	
		(V)	(V)	(V)	(V)	(A)	(A)	(W)	(J)	(pF)	(mm)			
TVR14181-D	TVR14181KSW	180 (162~198)	115	150	300	50	8000	0.6	60	1000	2.4	4.3	1.6	For SPD Type 3 Application
TVR14201-D	TVR14201KSW	200 (180~220)	130	170	340	50	8000	0.6	82	900	2.5	4.4	1.7	
TVR14221-D	TVR14221KSW	220 (198~242)	140	180	360	50	8000	0.6	90	850	2.5	4.4	1.7	
TVR14241-D	TVR14241KSW	240 (216~264)	150	200	395	50	8000	0.6	98	780	2.7	4.6	1.8	
TVR14271-D	TVR14271KSW	270 (243~297)	175	225	455	50	8000	0.6	116	650	2.8	4.8	1.9	
TVR14301-D	TVR14301KSW	300 (270~330)	195	250	500	50	8000	0.6	128	610	3.1	4.8	2.1	
TVR14331-D	TVR14331KSW	330 (297~363)	215	275	550	50	8000	0.6	140	580	3.2	4.9	2.2	
TVR14361-D	TVR14361KSW	360 (324~396)	230	300	595	50	8000	0.6	158	550	3.3	5.0	2.3	
TVR14391-D	TVR14391KSW	390 (351~429)	250	320	650	50	8000	0.6	170	520	3.5	5.2	2.5	
TVR14431-D	TVR14431KSW	430 (387~473)	275	350	710	50	8000	0.6	185	480	3.4	5.5	2.5	
TVR14471-D	TVR14471KSW	470 (423~517)	300	385	775	50	8000	0.6	205	460	3.6	5.6	2.6	
TVR14511-D	TVR14511KSW	510 (459~561)	320	410	845	50	8000	0.6	220	430	3.8	5.8	2.8	
TVR14561-D	TVR14561KSW	560 (504~616)	350	450	930	50	8000	0.6	240	390	4.0	5.9	3.0	
TVR14621-D	TVR14621KSW	620 (558~682)	395	510	1020	50	8000	0.6	250	350	4.3	6.3	3.2	
TVR14681-D	TVR14681KSW	680 (612~748)	420	560	1120	50	8000	0.6	260	320	4.5	6.6	3.4	
TVR14751-D	TVR14751KSW	750 (675~825)	465	615	1235	50	8000	0.6	270	290	4.8	6.8	3.7	
TVR14821-D	TVR14821KSW	820 (738~902)	510	670	1355	50	8000	0.6	280	250	4.9	6.8	3.4	
TVR14911-D	TVR14911KSW	910 (819~1001)	550	745	1500	50	8000	0.6	295	230	5.3	7.2	3.7	
TVR14102-D	TVR14102KSW	1000(900~1100)	625	825	1650	50	8000	0.6	335	210	5.7	7.5	4.0	
TVR14112-D	TVR14112KSW	1100(990~1210)	680	895	1815	50	8000	0.6	360	190	5.8	8.0	4.3	

# Metal Oxide Varistor : TVR-D Series

## Disc Type Varistor for Surge Protection (High Surge Series)

### 20-D Series

Certified Model No.	Part No.	Varistor Voltage (@ 1mA DC)	Max. Continuous Voltage			Max. Clamping Voltage (8/20µs)		Max. Surge Current (8/20µs)	Rated Power	Max. Energy (10/1000µs)	Reference Capacitance @1KHz	Dimension			UL 1449 3 <sup>rd</sup> SPD Application
		V <sub>1mA</sub>	V <sub>AC(rms)</sub>	V <sub>DC</sub>	V <sub>P</sub>	I <sub>P</sub>	I <sub>max</sub>	P	W <sub>max</sub>	C <sub>p</sub>	T <sub>min</sub>	T <sub>max</sub>	W ±1.0		
		(V)	(V)	(V)	(V)	(A)	(A)	(W)	(J)	(pF)	(mm)				
TVR20181-D	TVR20181KSW	180 (162~198)	115	150	300	100	13000	1.0	152	2200	2.8	4.7	1.8	For SPD Type 3 Application	
TVR20201-D	TVR20201KSW	200 (180~220)	130	170	340	100	13000	1.0	175	1900	2.9	4.8	1.9		
TVR20221-D	TVR20221KSW	220 (198~242)	140	180	360	100	13000	1.0	185	1700	2.9	4.8	1.9		
TVR20241-D	TVR20241KSW	240 (216~264)	150	200	395	100	13000	1.0	198	1500	3.1	5.0	2.0		
TVR20271-D	TVR20271KSW	270 (243~297)	175	225	455	100	13000	1.0	220	1400	3.2	5.2	2.1		
TVR20301-D	TVR20301KSW	300 (270~330)	195	250	500	100	13000	1.0	245	1300	3.5	5.2	2.3		
TVR20331-D	TVR20331KSW	330 (297~363)	215	275	550	100	13000	1.0	268	1200	3.6	5.3	2.4		
TVR20361-D	TVR20361KSW	360 (324~396)	230	300	595	100	13000	1.0	315	1000	3.7	5.4	2.5		
TVR20391-D	TVR20391KSW	390 (351~429)	250	320	650	100	13000	1.0	350	880	3.9	5.6	2.7		
TVR20431-D	TVR20431KSW	430 (387~473)	275	350	710	100	13000	1.0	380	800	3.8	5.9	2.7		
TVR20471-D	TVR20471KSW	470 (423~517)	300	385	775	100	13000	1.0	405	700	4.0	6.0	2.8		
TVR20511-D	TVR20511KSW	510 (459~561)	320	410	845	100	13000	1.0	445	630	4.2	6.2	3.0		
TVR20561-D	TVR20561KSW	560 (504~616)	350	450	930	100	13000	1.0	475	530	4.4	6.3	3.2		
TVR20621-D	TVR20621KSW	620 (558~682)	395	510	1020	100	13000	1.0	490	490	4.7	6.7	3.4		
TVR20681-D	TVR20681KSW	680 (612~748)	420	560	1120	100	13000	1.0	500	470	4.9	7.0	3.6		
TVR20751-D	TVR20751KSW	750 (675~825)	465	615	1235	100	13000	1.0	525	450	5.2	7.2	3.9		
TVR20821-D	TVR20821KSW	820 (738~902)	510	670	1355	100	13000	1.0	545	410	5.3	7.2	3.6		
TVR20911-D	TVR20911KSW	910 (819~1001)	550	745	1500	100	13000	1.0	595	380	5.7	7.6	3.9		
TVR20102-D	TVR20102KSW	1000(900~1100)	625	825	1650	100	13000	1.0	650	360	6.1	7.9	4.2		
TVR20112-D	TVR20112KSW	1100(990~1210)	680	895	1815	100	13000	1.0	720	340	6.2	8.4	4.5		

# Metal Oxide Varistor : TVR-D Series

## Disc Type Varistor for Surge Protection (High Surge Series)

### 20-D for SPD Type 2 Application Series

Certified Model No.	Part No.	Varistor Voltage (@ 1mA DC)	Max. Continuous Voltage			Max. Clamping Voltage (8/20µs)		Max. Surge Current (8/20µs)	Nominal Discharge Current *1 (8/20us)	Rated Power	Max. Energy (10/1000µs)	Reference Capacitance @1KHz	Dimension			UL 1449 3 <sup>rd</sup> SPD Application
		V <sub>1mA</sub>	V <sub>AC(rms)</sub>	V <sub>DC</sub>	V <sub>P</sub>	I <sub>P</sub>	I <sub>max</sub>	I <sub>n</sub>	P	W <sub>max</sub>	C <sub>p</sub>	T <sub>min</sub>	T <sub>max</sub>	W ±1.0		
		(V)	(V)	(V)	(V)	(A)	(A)	(A)	(W)	(J)	(pF)	(mm)				
TVR20181-S	TVR20181KSS	180(162~198)	115	150	300	100	13000	5000	1.0	152	2200	2.8	4.7	1.8	For SPD Type 2 Application	
TVR20201-S	TVR20201KSS	200(180~220)	130	170	340	100	13000	5000	1.0	175	1900	2.9	4.8	1.9		
TVR20221-S	TVR20221KSS	220(198~242)	140	180	360	100	13000	5000	1.0	185	1700	2.9	4.8	1.9		
TVR20241-S	TVR20241KSS	240(216~264)	150	200	395	100	13000	5000	1.0	198	1500	3.1	5.0	2.0		
TVR20271-S	TVR20271KSS	270(243~297)	175	225	455	100	13000	5000	1.0	220	1400	3.2	5.2	2.1		
TVR20301-S	TVR20301KSS	300(270~330)	195	250	500	100	13000	5000	1.0	245	1300	3.5	5.2	2.3		
TVR20331-S	TVR20331KSS	330(297~363)	215	275	550	100	13000	5000	1.0	268	1200	3.6	5.3	2.4		
TVR20361-S	TVR20361KSS	360(324~396)	230	300	595	100	13000	5000	1.0	315	1000	3.7	5.4	2.5		
TVR20391-S	TVR20391KSS	390(351~429)	250	320	650	100	13000	5000	1.0	350	880	3.9	5.6	2.7		
TVR20431-S	TVR20431KSS	430(387~473)	275	350	710	100	13000	5000	1.0	380	800	3.8	5.9	2.7		
TVR20471-S	TVR20471KSS	470(423~517)	300	385	775	100	13000	5000	1.0	405	700	4.0	6.0	2.8		
TVR20511-S	TVR20511KSS	510(459~561)	320	410	845	100	13000	5000	1.0	445	630	4.2	6.2	3.0		
TVR20561-S	TVR20561KSS	560(504~616)	350	450	930	100	13000	5000	1.0	475	530	4.4	6.3	3.2		
TVR20621-S	TVR20621KSS	620(558~682)	395	510	1020	100	13000	5000	1.0	490	490	4.7	6.7	3.4		
TVR20681-S	TVR20681KSS	680(612~748)	420	560	1120	100	13000	5000	1.0	500	470	4.9	7.0	3.6		
TVR20751-S	TVR20751KSS	750(675~825)	465	615	1235	100	13000	5000	1.0	525	450	5.2	7.2	3.9		
TVR20821-S	TVR20821KSS	820(738~902)	510	670	1355	100	13000	5000	1.0	545	410	5.3	7.2	3.6		
TVR20911-S	TVR20911KSS	910(819~1001)	550	745	1500	100	13000	5000	1.0	595	380	5.7	7.6	3.9		
TVR20102-S	TVR20102KSS	1000(900~1100)	625	825	1650	100	13000	5000	1.0	650	360	6.1	7.9	4.2		
TVR20112-S	TVR20112KSS	1100(990~1210)	680	895	1815	100	13000	5000	1.0	720	340	6.2	8.4	4.5		

Note:



\*1: Nominal discharge current is the specification defined in UL 1449 3<sup>rd</sup> and use 8/20µs current waveform to test the varistor.





# Metal Oxide Varistor : TVR-D Series

## Disc Type Varistor for Surge Protection (High Surge Series)

Certified Model No.	Agency				
					
	UL1449 3 <sup>rd</sup> & cUL: E314979	40021243	IEC60950-1:2013 Annex Q	GB/T10193-1997 GB/T10194-1997 CQC10001041750 CQC10001041751	GB8898-2011 GB4943.1-2011 CQC10001041750 CQC10001041751
TVR14181-D	√	√	√	√	
TVR14201-D	√	√	√	√	√
TVR14221-D	√	√	√	√	√
TVR14241-D	√	√	√	√	√
TVR14271-D	√	√	√	√	√
TVR14301-D	√	√	√	√	√
TVR14331-D	√	√	√	√	√
TVR14361-D	√	√	√	√	√
TVR14391-D	√	√	√	√	√
TVR14431-D	√	√	√	√	√
TVR14471-D	√	√	√	√	√
TVR14511-D	√	√	√	√	√
TVR14561-D	√	√	√	√	√
TVR14621-D	√	√	√	√	√
TVR14681-D	√	√	√	√	√
TVR14751-D	√	√	√	√	√
TVR14821-D	√	√	√	√	√
TVR14911-D	√	√	√	√	√
TVR14102-D	√	√	√	√	√
TVR14112-D	√	√	√	√	√
TVR20181-D / -S	√	√	√	√	
TVR20201-D / -S	√	√	√	√	√
TVR20221-D / -S	√	√	√	√	√
TVR20241-D / -S	√	√	√	√	√
TVR20271-D / -S	√	√	√	√	√
TVR20301-D / -S	√	√	√	√	√
TVR20331-D / -S	√	√	√	√	√
TVR20361-D / -S	√	√	√	√	√
TVR20391-D / -S	√	√	√	√	√
TVR20431-D / -S	√	√	√	√	√
TVR20471-D / -S	√	√	√	√	√
TVR20511-D / -S	√	√	√	√	√
TVR20561-D / -S	√	√	√	√	√
TVR20621-D / -S	√	√	√	√	√
TVR20681-D / -S	√	√	√	√	√
TVR20751-D / -S	√	√	√	√	√
TVR20821-D / -S	√	√	√	√	√
TVR20911-D / -S	√	√	√	√	√
TVR20102-D / -S	√	√	√	√	√
TVR20112-D / -S	√	√	√	√	√

# Metal Oxide Varistor : TVR-D Series

## Disc Type Varistor for Surge Protection (High Surge Series)

### Power Derating Curve

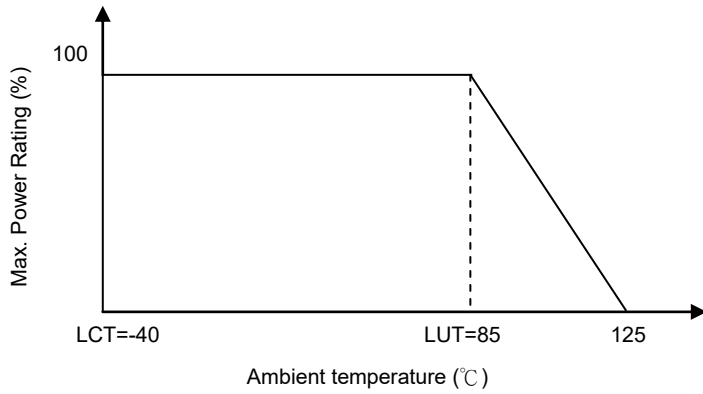

### Surge Current Standard Waveform

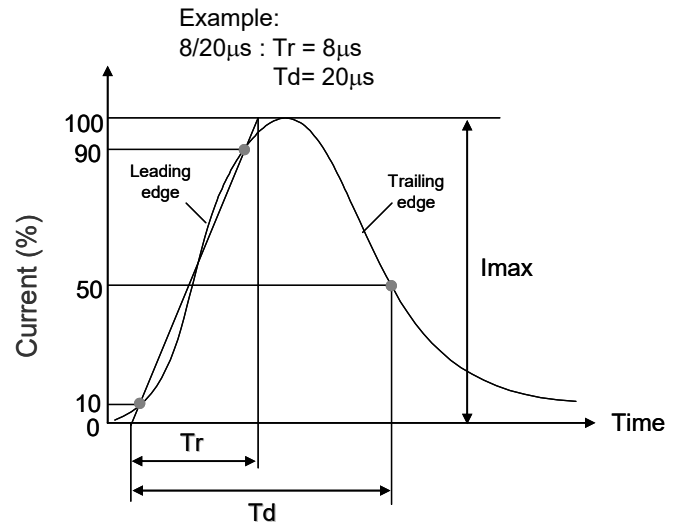

### Max. Surge Current Derating Curves

TVR07181-D to TVR07471-D

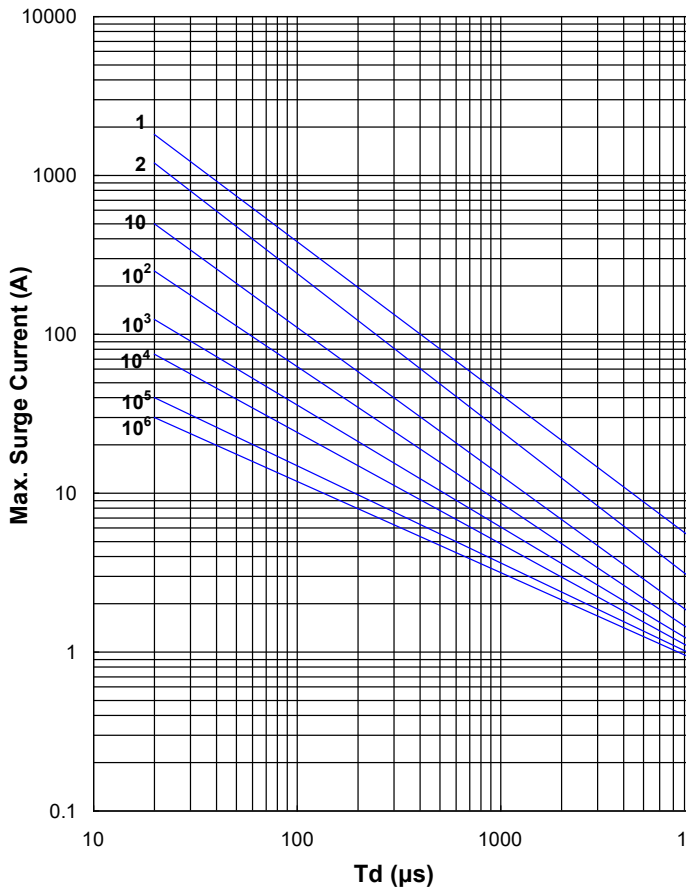

TVR07511-D to TVR07821-D

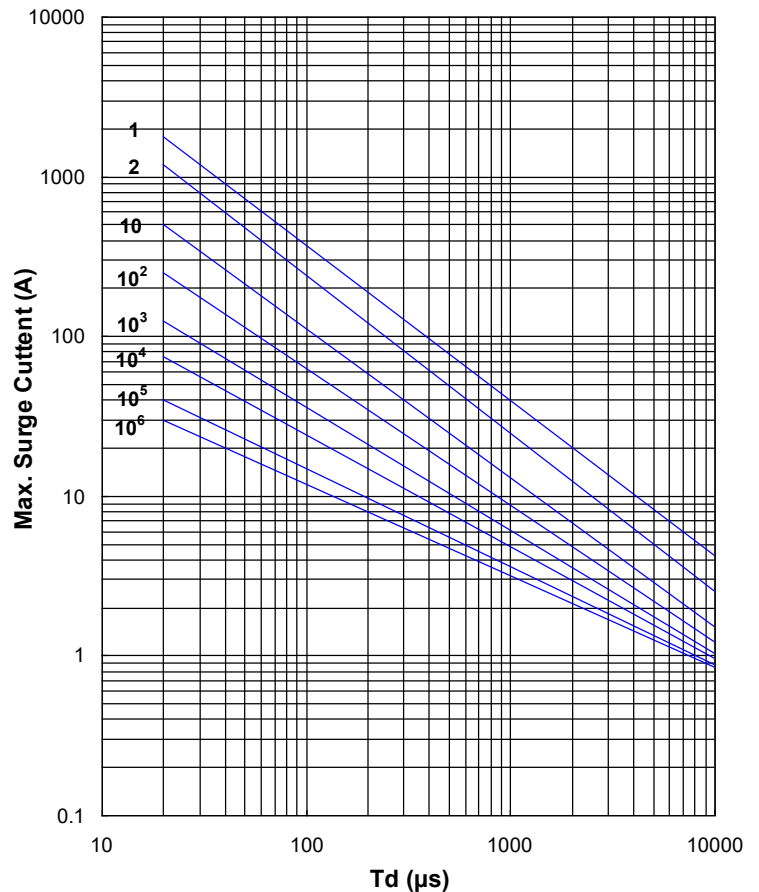

# Metal Oxide Varistor : TVR-D Series

## Disc Type Varistor for Surge Protection (High Surge Series)

### ■ Max. Surge Current Derating Curves

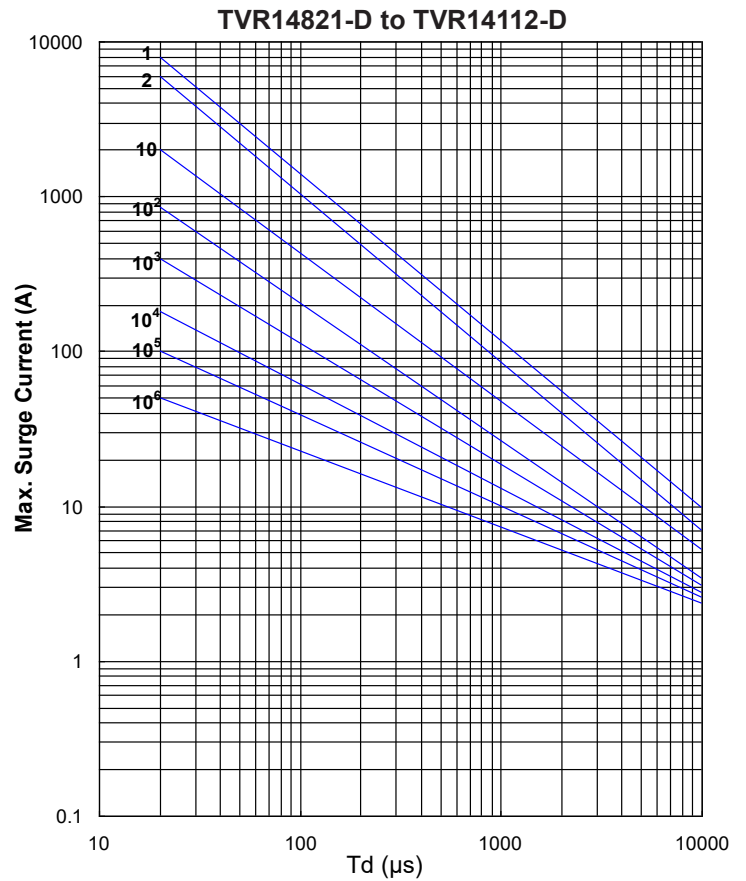
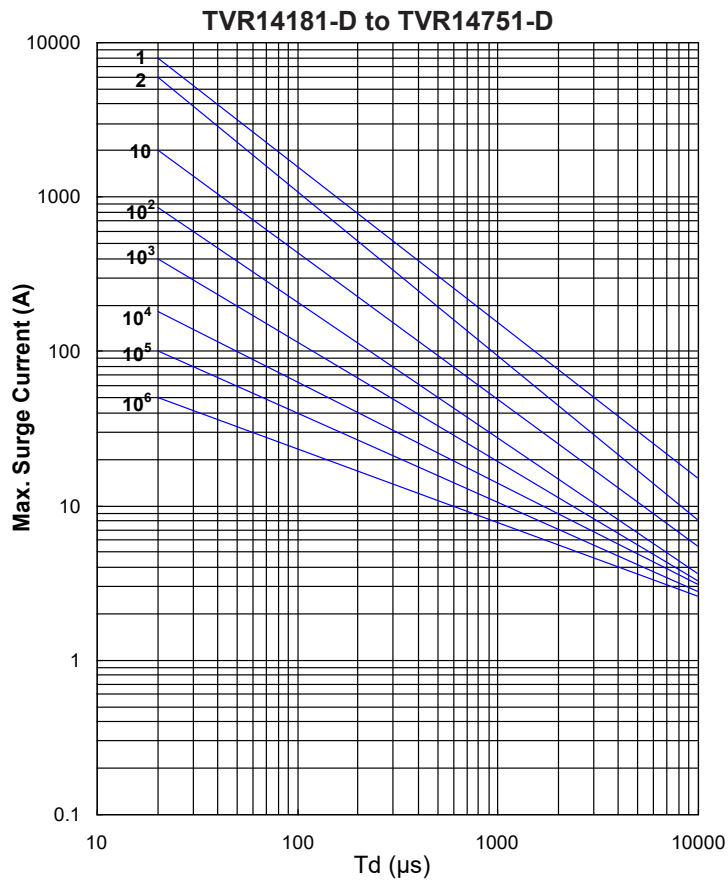
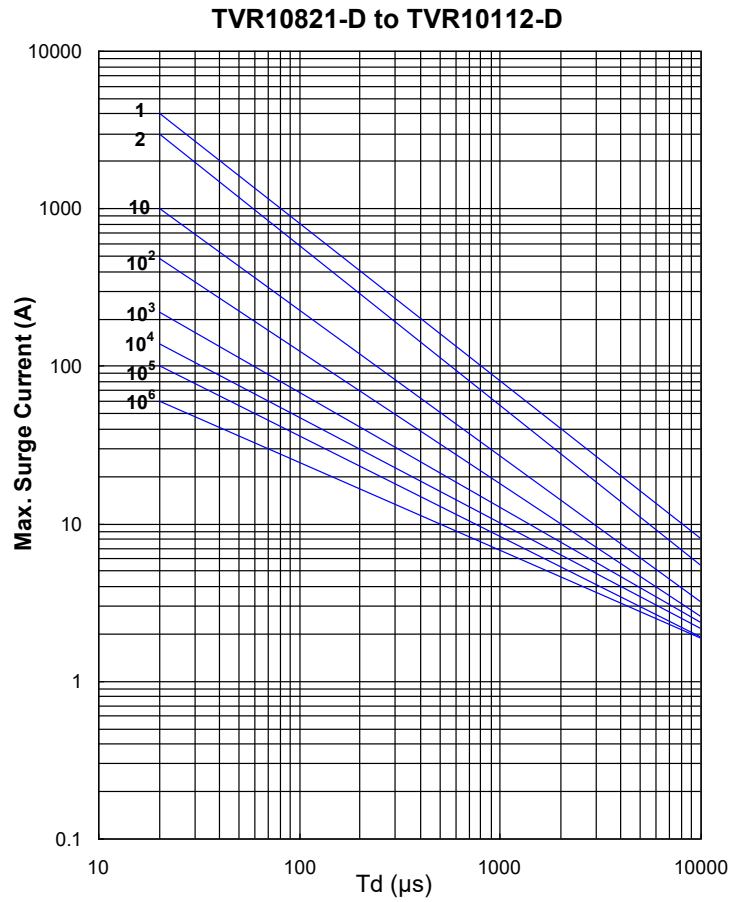
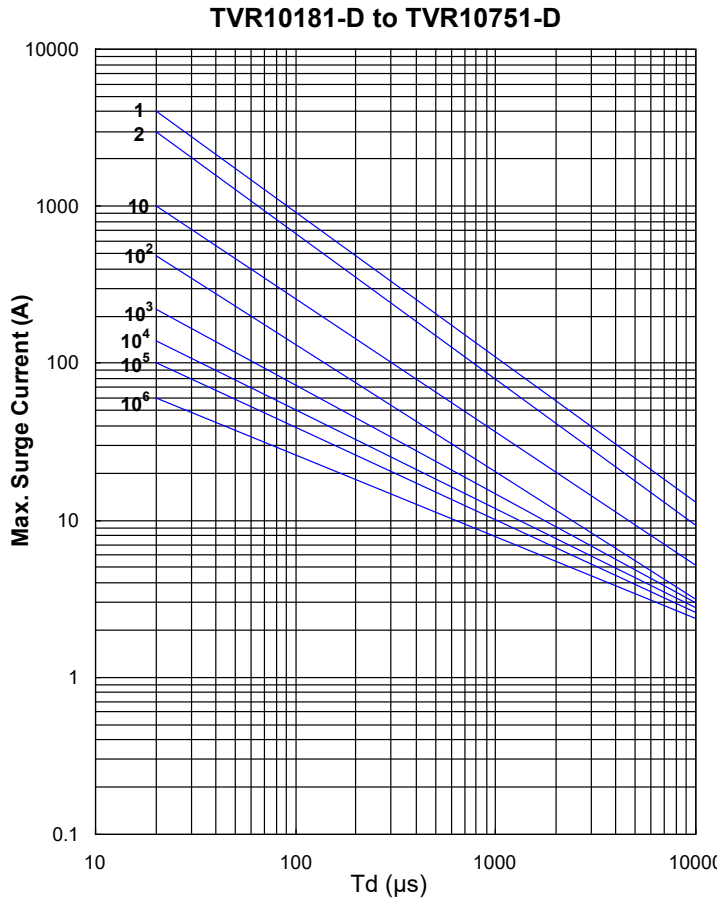

# Metal Oxide Varistor : TVR-D Series

## Disc Type Varistor for Surge Protection (High Surge Series)

### Max. Surge Current Derating Curves

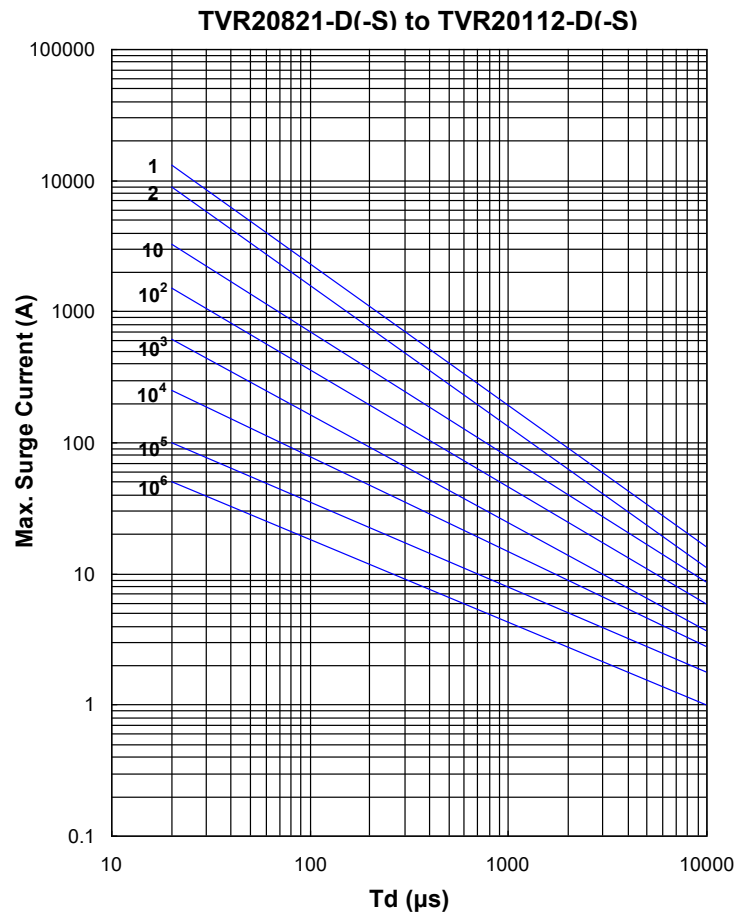
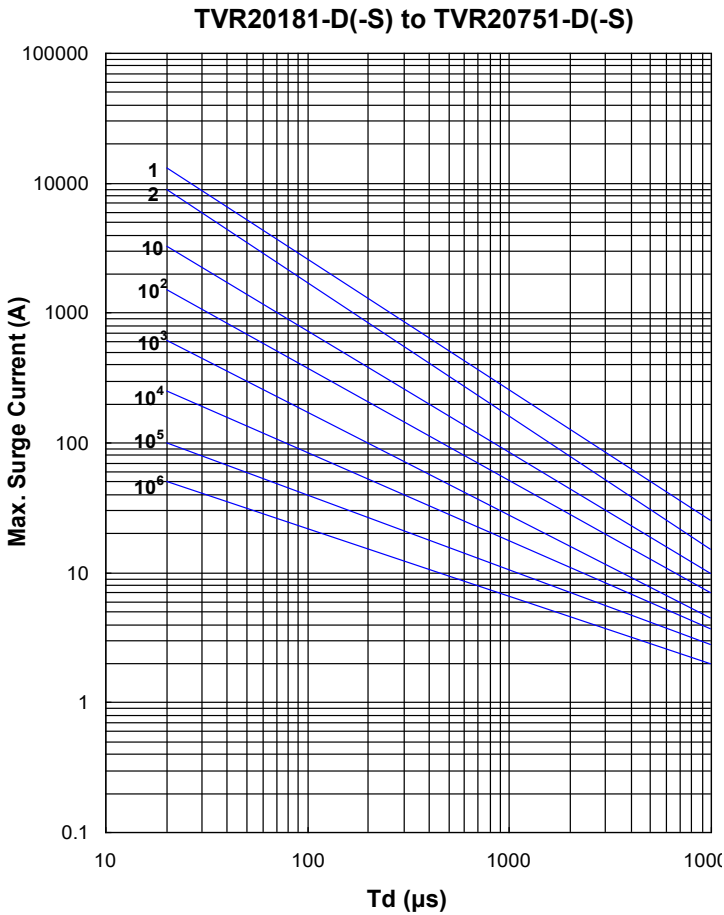

### Max. Leakage Current and Max. Clamping Voltage Curves

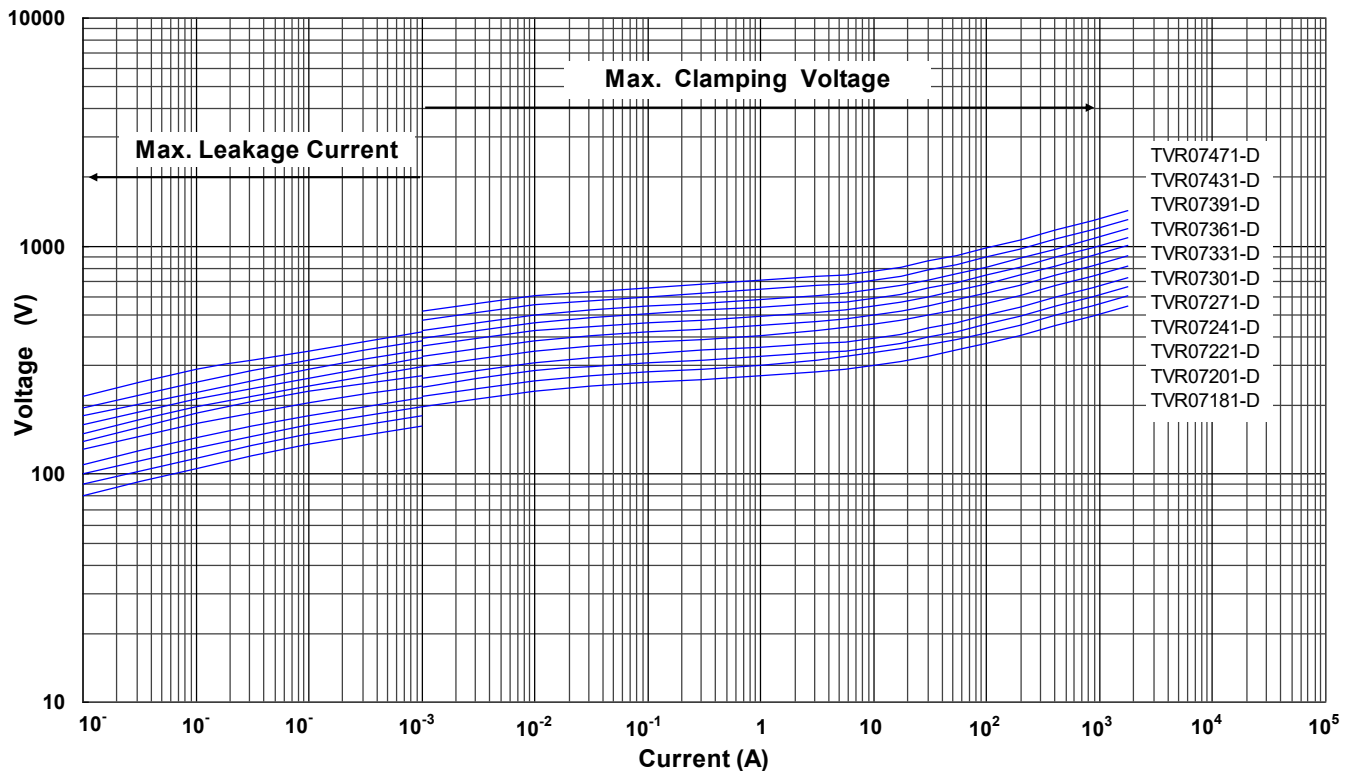

# Metal Oxide Varistor : TVR-D Series

## Disc Type Varistor for Surge Protection (High Surge Series)

### Max. Leakage Current and Max. Clamping Voltage Curves

Max. Leakage Current and Max. Clamping Voltage Curves (TVR07511-D to TVR07821-D)

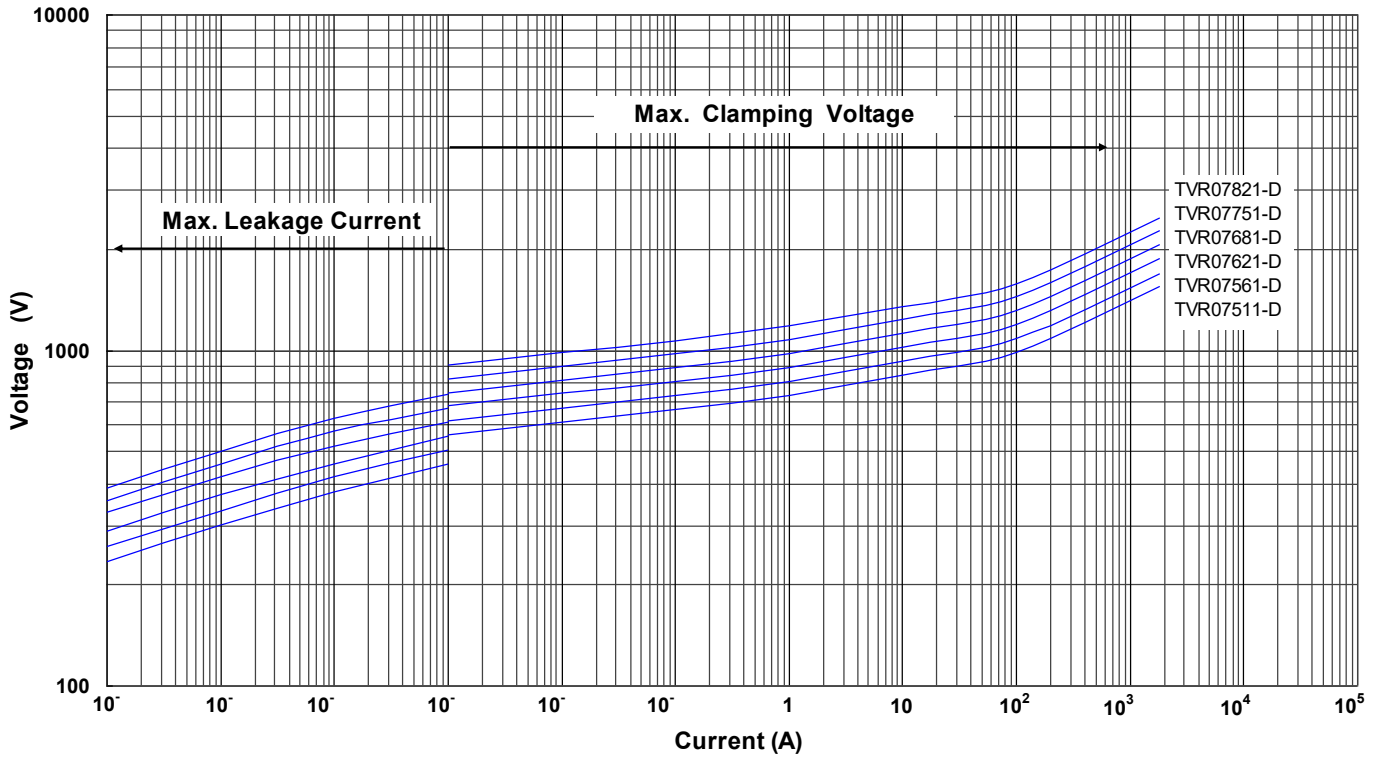

Max. Leakage Current and Max. Clamping Voltage Curves (TVR10181-D to TVR10471-D)

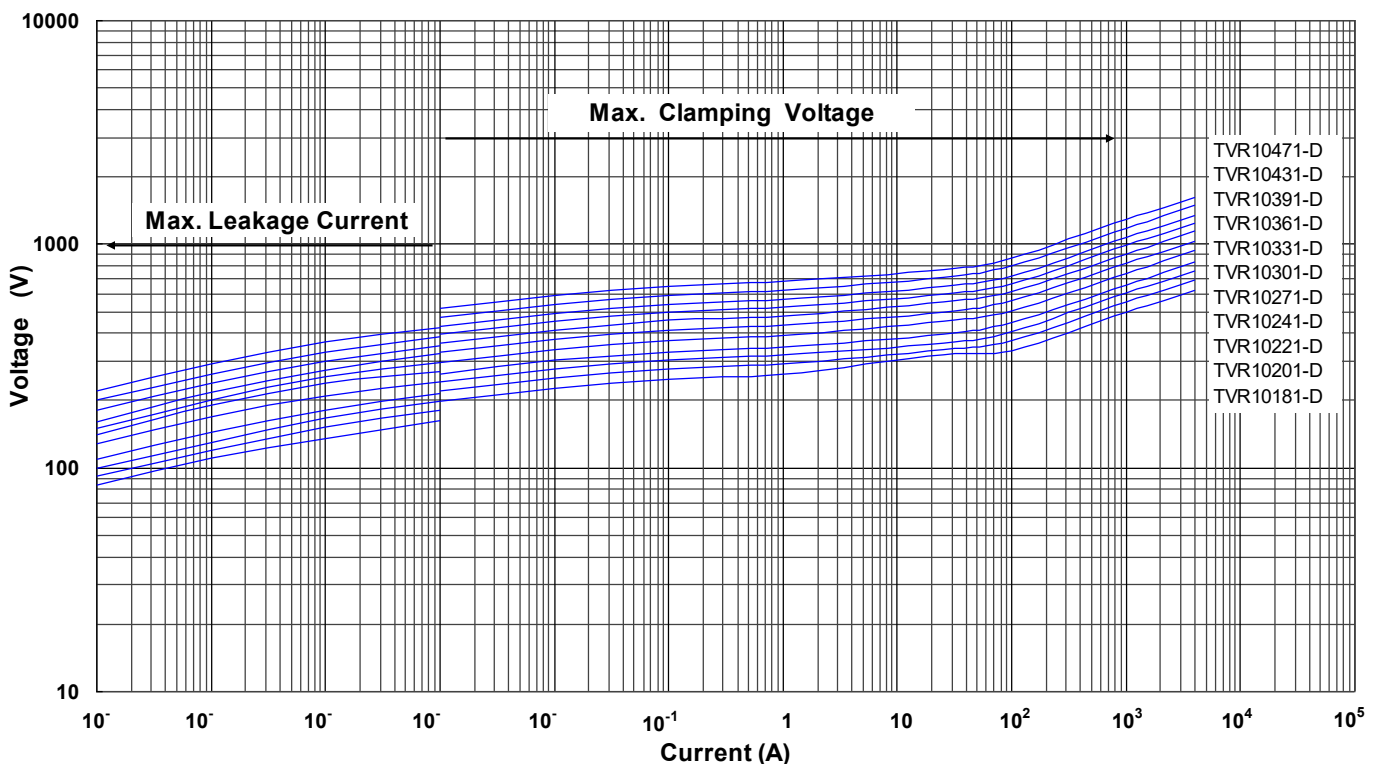

# Metal Oxide Varistor : TVR-D Series

## Disc Type Varistor for Surge Protection (High Surge Series)

### Max. Leakage Current and Max. Clamping Voltage Curves

Max. Leakage Current and Max. Clamping Voltage Curves (TVR10511-D to TVR10112-D)

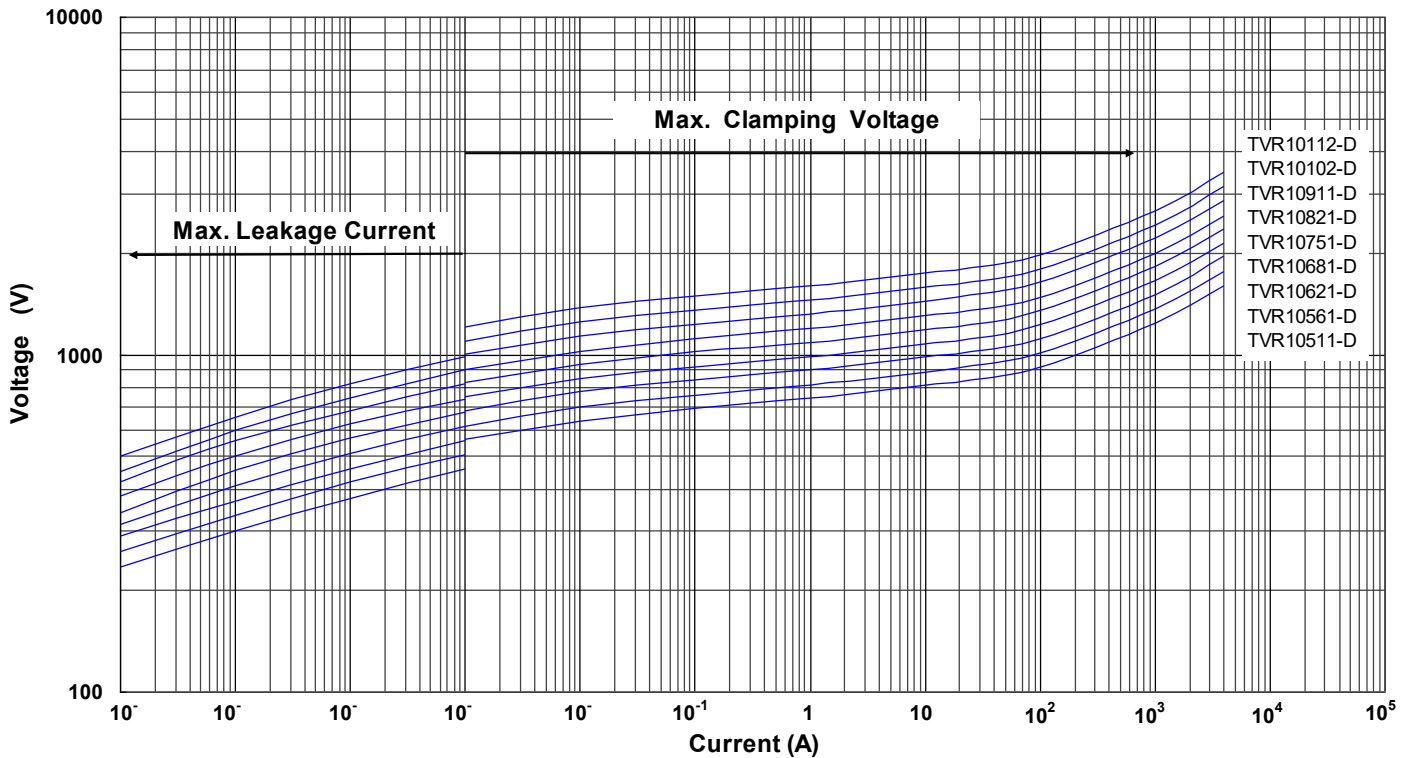

Max. Leakage Current and Max. Clamping Voltage Curves (TVR14181-D to TVR14471-D)

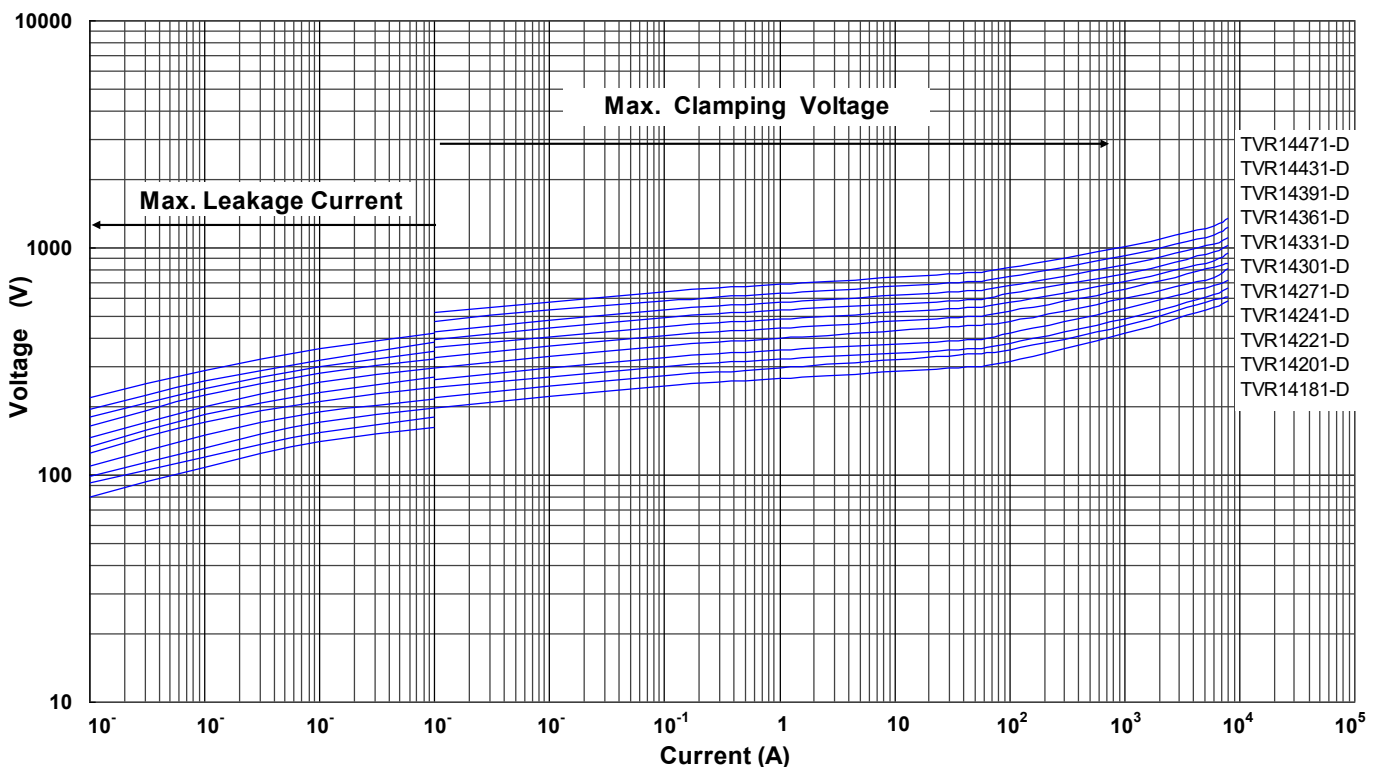

## Disc Type Varistor for Surge Protection (High Surge Series)

### ■ Max. Leakage Current and Max. Clamping Voltage Curves

Max. Leakage Current and Max. Clamping Voltage Curves (TVR14511-D to TVR14112-D)

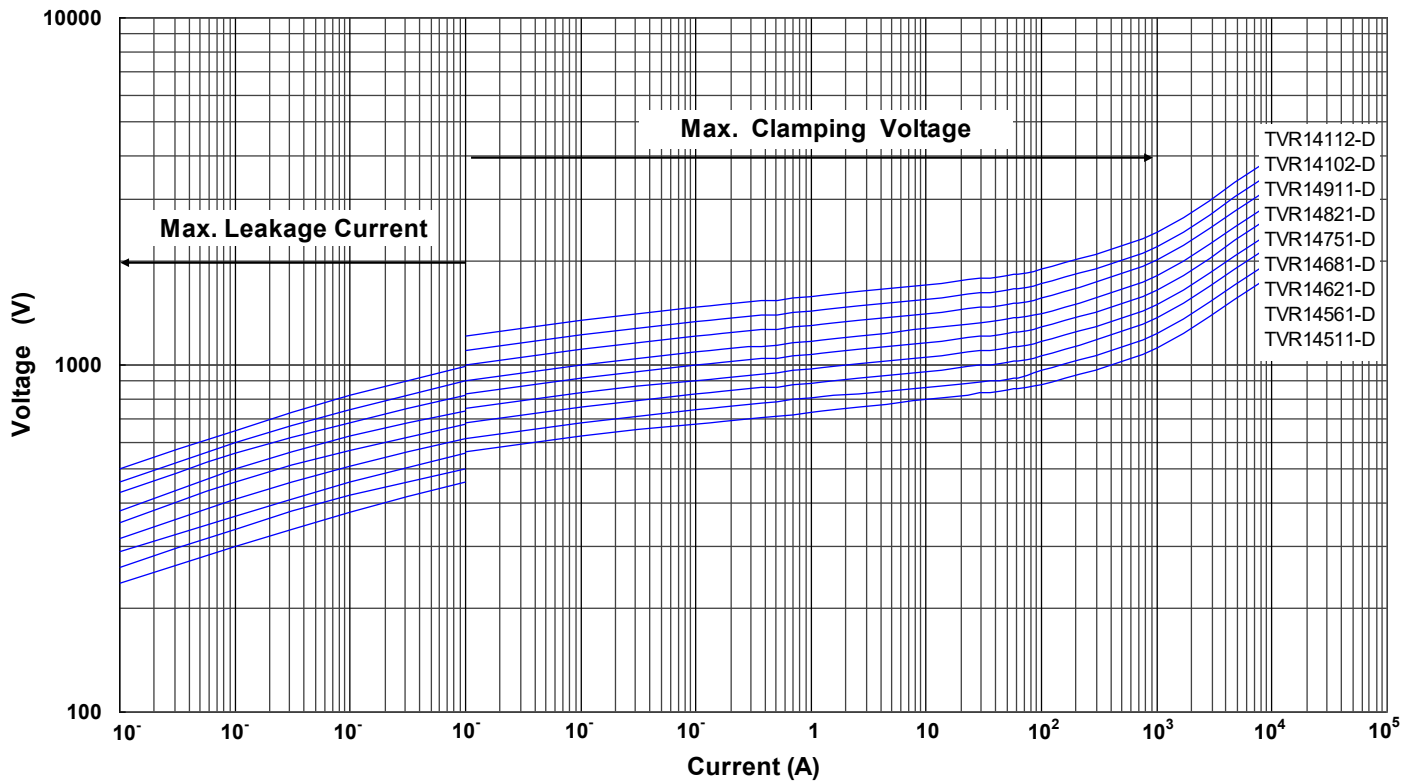

Max. Leakage Current and Max. Clamping Voltage Curves (TVR20481-D(S) to TVR20471-D(S))

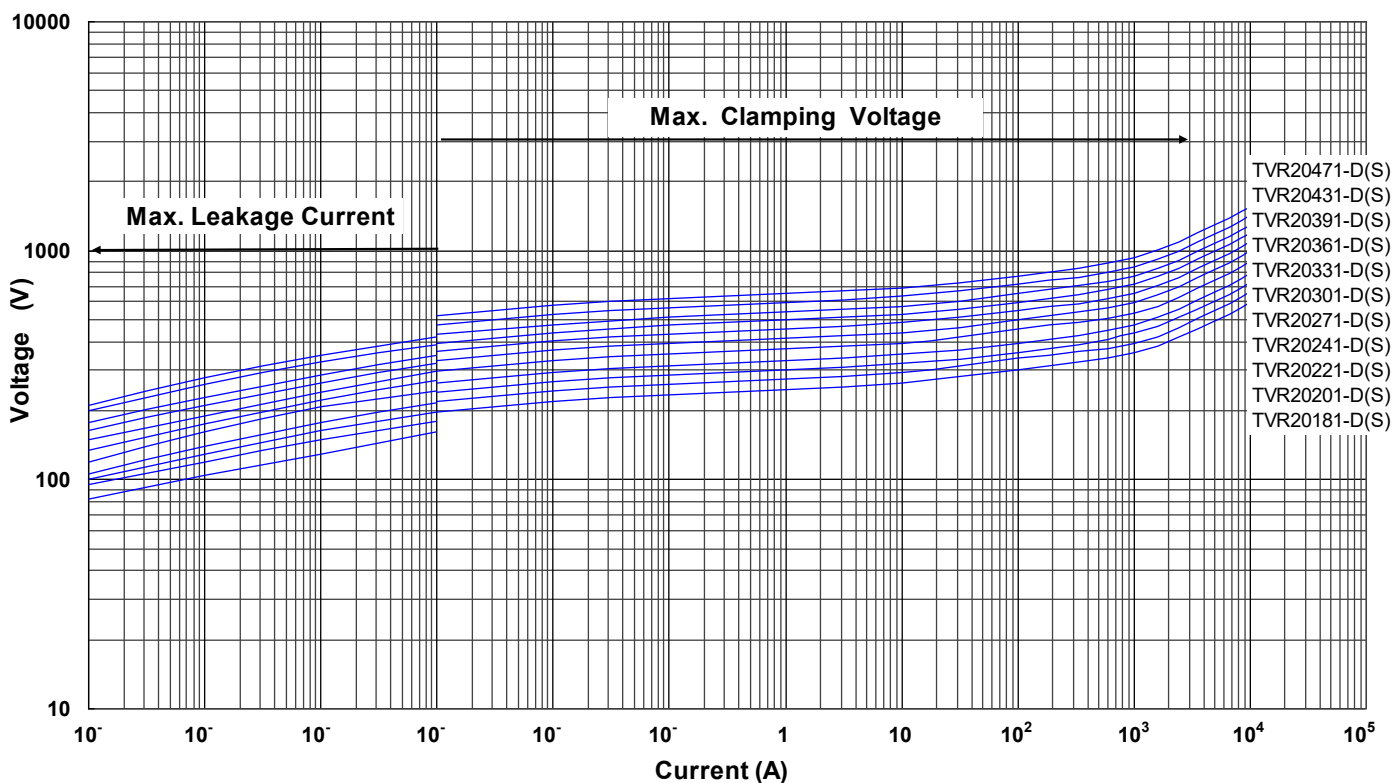



# Metal Oxide Varistor : TVR-D Series

## Disc Type Varistor for Surge Protection (High Surge Series)

### ■ Max. Leakage Current and Max. Clamping Voltage Curves

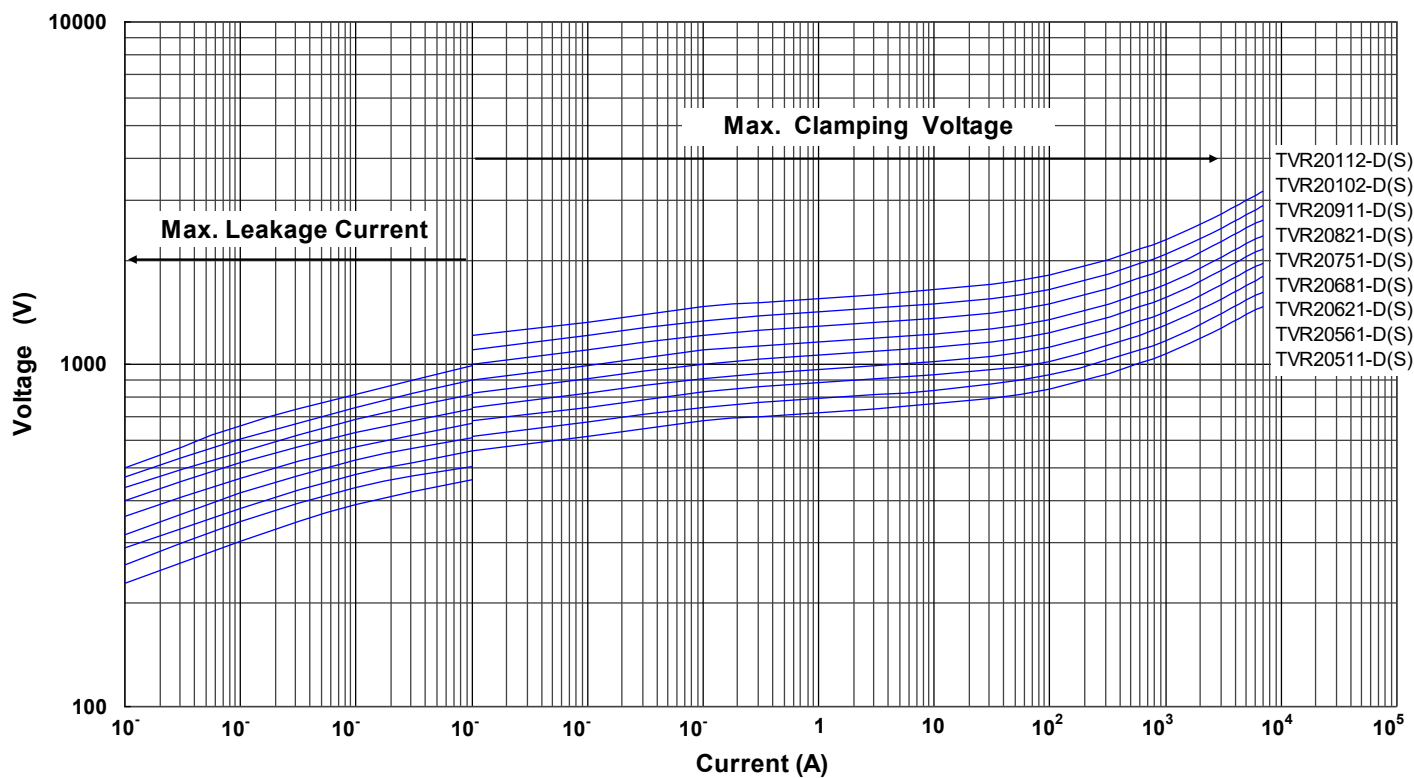

## Disc Type Varistor for Surge Protection (High Surge Series)

### ■ Soldering Recommendation

#### ● Wave Soldering Profile

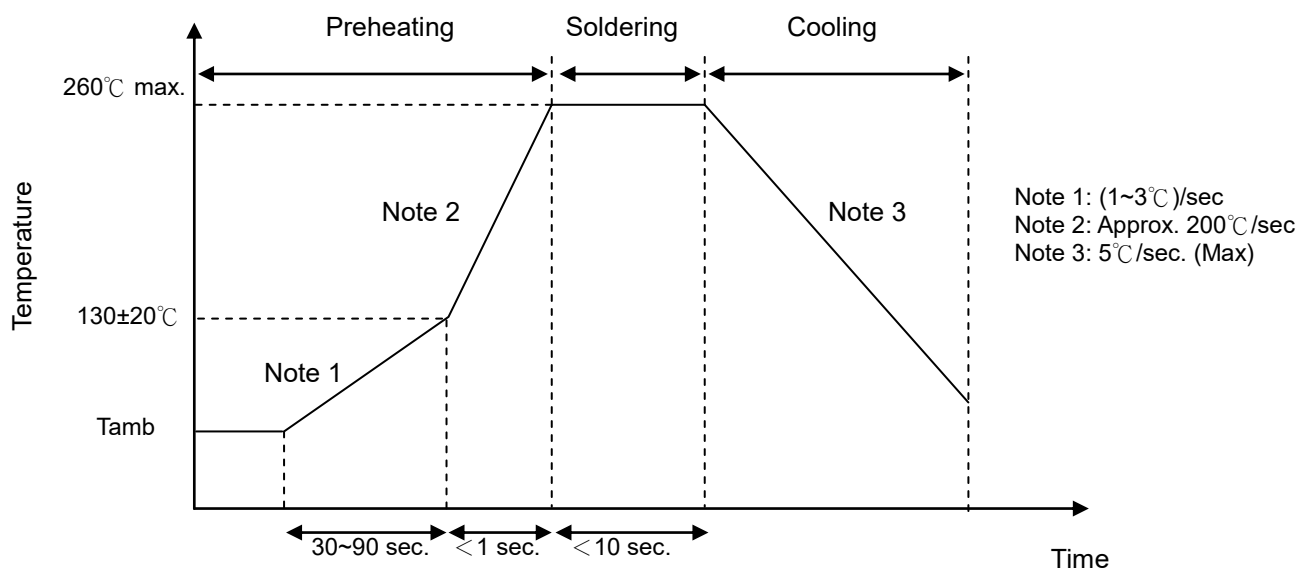

#### ● Recommended Reworking Conditions with Soldering Iron

Item	Conditions
Temperature of Soldering Iron-tip	360°C (max.)
Soldering Time	3 sec (max.)
Distance from Varistor	2 mm (min.)

# Metal Oxide Varistor : TVR-D Series

## Disc Type Varistor for Surge Protection (High Surge Series)

### ■ Reliability

Item	Standard	Test conditions / Methods	Specifications															
Tensile Strength of Terminations	IEC 60068-2-21	Gradually apply the specified force and keep the unit fixed for 10±1 sec.  Terminal diameter (mm)                      Force (Kg) 0.5<d≤0.8                                      1.0 0.8<d≤1.25                                      2.0	$ \Delta V_{1mA}/V_{1mA}  \leq 5\%$ No visible damage															
Bending Strength of Terminals	IEC 60068-2-21	Hold specimen and apply the force specified below to each lead. Bend the specimen to 90°, then return to the original position. Repeat the procedure in the opposite direction.  Terminal diameter (mm)                      Force (Kg) 0.5<d≤0.8                                      0.5 0.8<d≤1.25                                      1.0	$ \Delta V_{1mA}/V_{1mA}  \leq 5\%$ No visible damage															
Vibration	IEC 60068-2-6	Frequency range: 10~55Hz Amplitude: 0.75mm or 98m/s <sup>2</sup> Direction: 3 mutually perpendicular directions, 2 hrs each.	$ \Delta V_{1mA}/V_{1mA}  \leq 5\%$ No visible damage															
Solderability	IEC 60068-2-20	245±5°C , 3±0.3 sec.	At least 95% of terminal electrode is covered by new solder															
Resistance to Soldering Heat	IEC 60068-2-20	260±3°C , 10±1 sec	$ \Delta V_{1mA}/V_{1mA}  \leq 5\%$ No visible damage															
High Temperature Storage	IEC 60068-2-2	125±5°C x 1000 hrs ± 24hrs	$ \Delta V_{1mA}/V_{1mA}  \leq 5\%$ No visible damage															
Damp Heat, Steady State	IEC 60068-2-78	a. 40±2°C, 90 ~ 95 % RH, 1344 hrs b. 40±2°C, 90~ 95 % RH , at 10% Vdc, 1344 hrs	$ \Delta V_{1mA}/V_{1mA}  \leq 5\%$ No visible damage Insulation Resistance ≥ 100MΩ															
Rapid Change of Temperature	IEC 60068-2-14	The conditions shown below shall be repeated 5 cycles <table border="1"> <thead> <tr> <th>Step</th> <th>Temperature (°C)</th> <th>Period (minutes)</th> </tr> </thead> <tbody> <tr> <td>1</td> <td>-40±3</td> <td>30±3</td> </tr> <tr> <td>2</td> <td>Room temperature</td> <td>5±3</td> </tr> <tr> <td>3</td> <td>85±2</td> <td>30±3</td> </tr> <tr> <td>4</td> <td>Room temperature</td> <td>5±3</td> </tr> </tbody> </table>	Step	Temperature (°C)	Period (minutes)	1	-40±3	30±3	2	Room temperature	5±3	3	85±2	30±3	4	Room temperature	5±3	$ \Delta V_{1mA}/V_{1mA}  \leq 5\%$ No visible damage
Step	Temperature (°C)	Period (minutes)																
1	-40±3	30±3																
2	Room temperature	5±3																
3	85±2	30±3																
4	Room temperature	5±3																
High Temp. Load	MIL-STD-202 Method 108	85±2°C, 1000±24 hrs at V <sub>DC</sub> or V <sub>rms</sub> (Max. Continuous Voltage)	$ \Delta V_{1mA}/V_{1mA}  \leq 10\%$ No visible damage															
8/20µs Surge Life	IEC 61051-1	8/20µs waveform, 10 surge currents, unipolar, interval 30 sec, amplitude corresponding to max. surge current derating curves for 20µs.	$ \Delta V_{1mA}/V_{1mA}  \leq 10\%$ No visible damage															
10/1000µs Surge Life	IEC 61051-1	10/1000µs waveform, 10 surge currents, unipolar, interval 2 mins, amplitude corresponding to max. surge current derating curves for 1000µs.	$ \Delta V_{1mA}/V_{1mA}  \leq 10\%$ No visible damage															
Operating Duty Cycle Test	UL1449 3 <sup>rd</sup>	6KV/3KA 1.2/50µs+8/20µs combination waveform with Vac(@ Deg 90) for 15 times. Interval time between tests is 60 secs. (For UL1449 3 <sup>rd</sup> SPD Type 3 application test only)	$ \Delta V_p/V_p  \leq 10\%$ No visible damage															
Nominal Discharge Current Test	UL1449 3 <sup>rd</sup>	Refer to UL 1449 3 <sup>rd</sup> item 37.7, the test condition is 3KA 8/20µs surge current waveform for 15 times (For TVR20R UL1449 3 <sup>rd</sup> SPD Type 2 application test only)	$ \Delta V_p/V_p  \leq 10\%$ No visible damage															
Voltage Proof	IEC 61051-1	Metal balls method, 2500 V <sub>ac</sub> 1 min	No visible damage															
Varistor Voltage Temp. Coefficient	Specification Standard	$\frac{V_{1mA@85^\circ C} - V_{1mA@25^\circ C}}{V_{1mA@25^\circ C}} \times \frac{1}{60} \times 100\% (\% / ^\circ C)$ , $\frac{V_{1mA@-40^\circ C} - V_{1mA@25^\circ C}}{V_{1mA@25^\circ C}} \times \frac{1}{65} \times 100\% (\% / ^\circ C)$	-0.05 ≤ TC ≤ 0.05 (%/°C)															

# Metal Oxide Varistor : TVR-D Series

## Disc Type Varistor for Surge Protection (High Surge Series)

### ■ Packaging

#### ● Taping Specification

#### S Type (Straight lead)

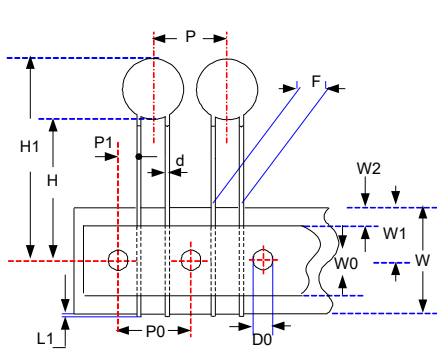

Figure A

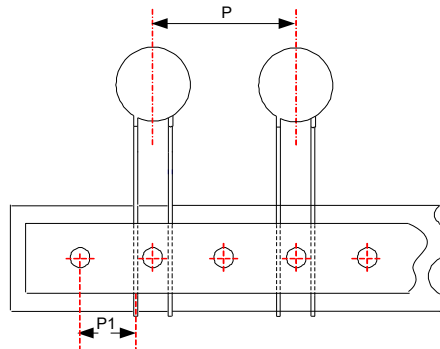

Figure B

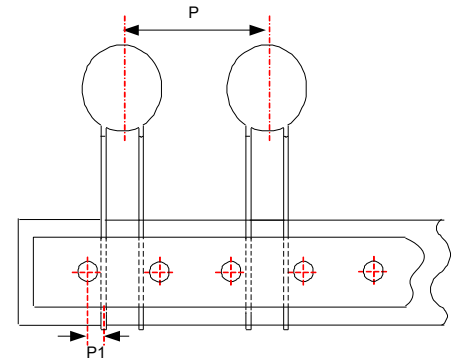
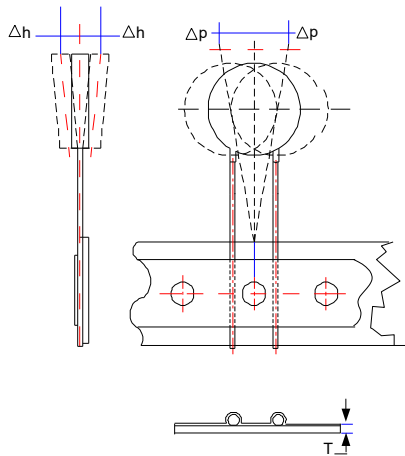

Figure C



(Unit: mm)

Taping Code	Series	P <sub>0</sub>	F	P	P <sub>1</sub>	H	H <sub>1</sub>	d	W <sub>0</sub>	W <sub>1</sub>	W <sub>2</sub>	W	Δ P	Δ h	L <sub>1</sub>	D <sub>0</sub>	T	Figure
		±0.3	±1	±1	±0.7	+2/-0	Max.	±0.02	±1	+0.75/-0.5	Max	+1/-0.5	Max.	Max.	Max.	±0.2	±0.2	
A (P <sub>0</sub> :12.7)	07-D	12.7	5.0	12.7	3.85	18	31	0.6	12	9	3	18	1	2	0.5	4	0.6	A
	10-D	12.7	7.5	25.4	8.95	18	36	0.8	12	9	3	18	1	2	0.5	4	0.6	B
	14-D	12.7	7.5	25.4	8.95	18	40	0.8	12	9	3	18	1	2	0.5	4	0.6	B
E (P <sub>0</sub> :15.0)	07-D	15.0	5.0	15.0	5.00	18	31	0.6	12	9	3	18	1	2	0.5	4	0.6	A
	10-D	15.0	7.5	15.0	3.75	18	36	0.8	12	9	3	18	1	2	0.5	4	0.6	A
	14-D	15.0	7.5	30.0	3.75	18	40	0.8	12	9	3	18	1	2	0.5	4	0.6	C

# Metal Oxide Varistor : TVR-D Series

## Disc Type Varistor for Surge Protection (High Surge Series)

### F Type (Y kink lead)

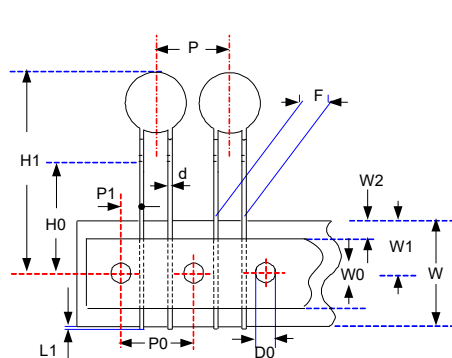

Figure A

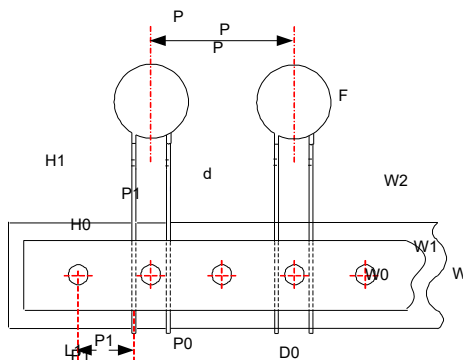

Figure B

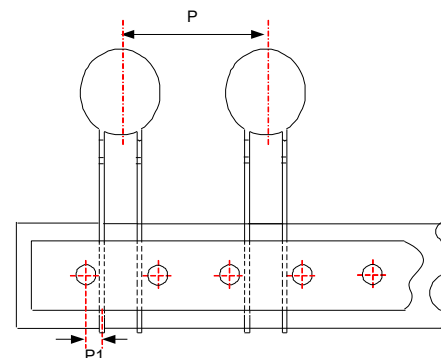
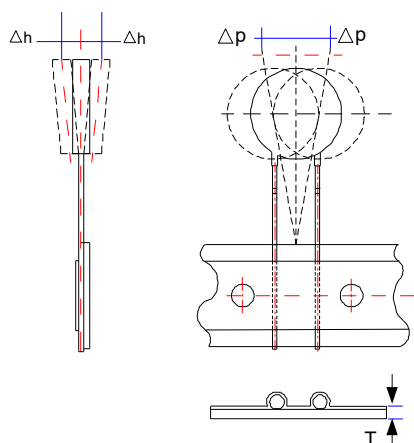

Figure C



(Unit: mm)

Taping Code	Series	P <sub>0</sub>	F	P	P <sub>1</sub>	H <sub>0</sub>	H <sub>1</sub>	d	W <sub>0</sub>	W <sub>1</sub>	W <sub>2</sub>	W	Δ P	Δ h	L <sub>1</sub>	D <sub>0</sub>	T	Figure
		±0.3	±1	±1	±0.7	+2/-0	Max.	±0.02	±1	+0.75/-0.5	Max	+1/-0.5	Max.	Max.	Max.	±0.2	±0.2	
A (P <sub>0</sub> :12.7)	07-D	12.7	5.0	12.7	3.85	16	31	0.6	12	9	3	18	1	2	0.5	4	0.6	A
	10-D	12.7	7.5	25.4	8.95	16	36	0.8	12	9	3	18	1	2	0.5	4	0.6	B
	14-D	12.7	7.5	25.4	8.95	16	40	0.8	12	9	3	18	1	2	0.5	4	0.6	B
E (P <sub>0</sub> :15.0)	07-D	15.0	5.0	15.0	5.00	16	31	0.6	12	9	3	18	1	2	0.5	4	0.6	A
	10-D	15.0	7.5	15.0	3.75	16	36	0.8	12	9	3	18	1	2	0.5	4	0.6	A
	14-D	15.0	7.5	30.0	3.75	16	40	0.8	12	9	3	18	1	2	0.5	4	0.6	C

# Metal Oxide Varistor : TVR-D Series

## Disc Type Varistor for Surge Protection (High Surge Series)

### ■ Quantity

#### ● Bulk Packing

Series	Straight Lead Type Quantity (pcs/bag)	Cut Lead Type Quantity (pcs/bag)	Kink Type Quantity (pcs/bag)
TVR07-D	250	250	200
TVR10-D	200	200	200
TVR14-D	100	100	100
TVR20-D	50	50	50

#### ● Reel Packing

Series	A (mm)	Quantity (pcs/reel)
TVR07(181~391) -D	46	1,500
TVR07(431~821) -D		1,000
TVR10(181~391) -D		1,000
TVR10 (431~561,681~911) -D		750
TVR10621-D		500
TVR10(102~112) -D		500
TVR14(181~331) -D	55	750
TVR14(361~112) -D		500
TVR20(181~681) -D		500
TVR20(751~112) -D		250

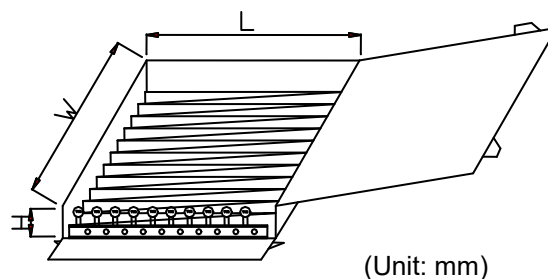
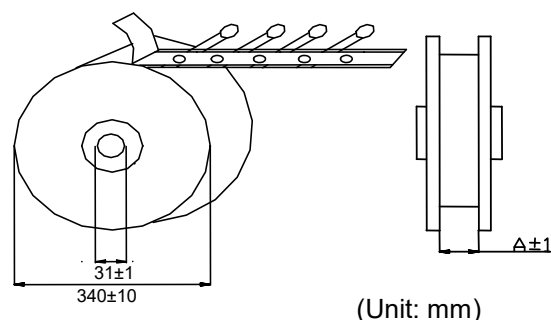

#### ● Ammo Packing

Series	Quantity (pcs/box)
TVR07(181~821) -D	1,000
TVR10(181~361) -D	750
TVR10(391~621) -D	400
TVR10(681~112) -D	300
TVR14(181~271) -D	500
TVR14(301~112) -D	250

Series	W±5	L±5	H±5
TVR07-D~ TVR14-D	348	185	60
	348	275	60

Note: The standard package for TVR20-D is bulk. For any other demand, please contact our sales person.

### ■ Warehouse Storage Conditions of Products

#### ● Storage Conditions:

1. Storage Temperature:  $-10^{\circ}\text{C} \sim +40^{\circ}\text{C}$
2. Relative Humidity:  $\leq 75\% \text{RH}$
3. Keep away from corrosive atmosphere and sunlight.

#### ● Period of Storage: 1 year