

Thermal Link P-F Series

2A Series





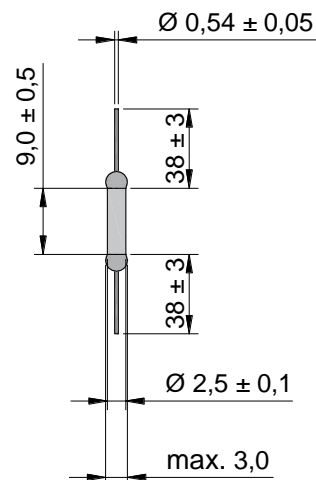

Key Features

- Ceramic case
- Non-resettable
- High accuracy of function temperature
- RoHS & REACH compliant

Dimensions



Specification

Model	T_f	Fusing Temp.	T_h	T_m	I_r	U_r							
	(°C)	(°C)	(°C)	(°C)	(A)	(V)	UL	cUL	VDE	PSE	CCC	KTL	RoHS REACH
P1-F	102	98±2	80	200	2	AC 250	•	•	•	•	•	•	•
P2-F	115	112±3	99	200	2	AC 250	•	•	•	•	•	•	•
P3-F	125	120±3	105	200	2	AC 250	•	•	•	•	•	•	•
P4-F	130	126±2	107	200	2	AC 250	•	•	•	•	•	•	•
P5-F	135	131±3	115	200	2	AC 250	•	•	•	•	•	•	•
P9-F	138	135±2	118	200	2	AC 250	•	•	•	•	•	•	•
P12-F	145	140±2	126	200	2	AC 250	•	•	•	•	•	•	•
P7-F	150	145±3	128	200	2	AC 250	•	•	•	•	•	•	•