

NTC Thermistor : SCK Series

Power Thermistor for Limiting Inrush Current

■ Electrical Characteristics

Part No.	Zero Power Resistance at 25°C	Max. Current at 25°C	Residual Resistance at 25°C I _{max}	Recommend Capacitance @240Vac	Max. Power Rating at 25°C	Dissipation Factor	Thermal Time Constant	Operating Temperature Range
	R ₂₅ (Ω)	I _{max} (A)	R _{I_{max}} (Ω)	C _{th} (μF)	P _{max} (W)	δ(mW/°C)	τ (Sec.)	T _L ~T _U (°C)
SCK13013□	1	3	0.174	560	3.1	Approx. 18	Approx. 66	-40 ~ +200
SCK131R37□	1.3	7	0.070	470				
SCK132R56□	2.5	6	0.094	560				
SCK13045□	4	5	0.132	560				
SCK134R74□	4.7	4	0.168	560				
SCK13055□	5	5	0.166	560				
SCK13074□	7	4	0.184	470				
SCK13084□	8	4	0.206	470				
SCK13104□	10	4	0.217	470				
SCK13124□	12	4	0.230	560				
SCK13153□	15	3	0.343	560				
SCK13163□	16	3	0.348	560				
SCK13183□	18	3	0.365	560				
SCK13203□	20	3	0.410	470				
SCK150R78A□	0.7	8	0.051	680	3.6	Approx. 21	Approx. 75	-40 ~ +200
SCK15018□	1	8	0.054	680				
SCK151R38□	1.3	8	0.064	680				
SCK151R58□	1.5	8	0.068	800				
SCK15028□	2	8	0.078	680				
SCK152R58□	2.5	8	0.086	680				
SCK15037□	3	7	0.091	820				
SCK15046□	4	6	0.117	800				
SCK15056□	5	6	0.121	820				
SCK15065□	6	5	0.159	680				
SCK15075□	7	5	0.161	820				
SCK15085□	8	5	0.165	680				
SCK15105□	10	5	0.178	820				
SCK15125□	12	5	0.185	680				
SCK15154□	15	4	0.261	820				
SCK15164□	16	4	0.265	820				
SCK15184□	18	4	0.273	680				
SCK15204□	20	4	0.283	820				
SCK15224□	22	4	0.308	560				
SCK15253□	25	3	0.425	680				
SCK15303□	30	3	0.461	680				
SCK15333□	33	3	0.484	560				
SCK15403□	40	3	0.511	680				
SCK15473□	47	3	0.517	680				
SCK15802X□	80	2.5	0.693	560				
SCK151202□	120	2	1.010	560				

Note 1: □ = Tolerance of R₂₅

Note 2: Special specifications are available upon request.

NTC Thermistor : SCK Series

Power Thermistor for Limiting Inrush Current

■ Electrical Characteristics

Part No.	Zero Power Resistance at 25°C	Max. Current at 25°C	Residual Resistance at 25°C I _{max}	Recommend Capacitance @240Vac	Max. Power Rating at 25°C	Dissipation Factor	Thermal Time Constant	Operating Temperature Range
	R ₂₅ (Ω)	I _{max} (A)	R _{I_{max}} (Ω)	C _{th} (μF)	P _{max} (W)	δ(mW/°C)	τ (Sec.)	T _L ~T _U (°C)
SCK200R7□	0.7	15	0.035	1000	4.9	Approx. 28	Approx. 113	-40 ~ +200
SCK201R0□	1	13	0.034					
SCK201R5□	1.5	10.5	0.041					
SCK202R0□	2	10	0.062					
SCK202R5□	2.5	9	0.083					
SCK203R0□	3	8.5	0.078					
SCK204R0□	4	8	0.080					
SCK204R7□	4.7	7.5	0.114					
SCK205R0□	5	7.5	0.118					
SCK206R0□	6	7	0.120					
SCK206R8□	6.8	6.5	0.130					
SCK207R0□	7	6.5	0.132					
SCK208R0□	8	6	0.161					
SCK20100□	10	5.5	0.196					
SCK20120□	12	5	0.197					
SCK20130□	13	5	0.213					
SCK20150□	15	4.5	0.258					
SCK20160□	16	4.5	0.276					
SCK20180□	18	4	0.280					
SCK20200□	20	4	0.306					
SCK251R0□	1	20	0.020	1200	7.0	Approx. 30	Approx. 130	-40 ~ +200
SCK251R5□	1.5	18.5	0.023					
SCK252R0□	2	18	0.025					
SCK252R5□	2.5	15	0.032					
SCK253R0□	3	14.5	0.042					
SCK254R0□	4	14	0.044					
SCK254R7□	4.7	13	0.052					
SCK255R0□	5	12	0.061					
SCK256R8□	6.8	10.5	0.082					
SCK257R0□	7	10	0.092					
SCK258R0□	8	9	0.115					
SCK25100□	10	8	0.141					
SCK25120□	12	7.5	0.164					
SCK25150□	15	6.5	0.210					
SCK25180□	18	5.5	0.231					
SCK25200□	20	5	0.270					

Note 1: □ = Tolerance of R₂₅

Note 2: Special specifications are available upon request.

NTC Thermistor : SCK Series

Power Thermistor for Limiting Inrush Current

■ Electrical Characteristics

Part No.	Zero Power Resistance at 25°C	Max. Current at 25°C	Residual Resistance at 25°C I _{max}	Recommend Capacitance @240Vac	Max. Power Rating at 25°C	Dissipation Factor	Thermal Time Constant	Operating Temperature Range
	R ₂₅ (Ω)	I _{max} (A)	R _{I_{max}} (Ω)	C _{th} (μF)	P _{max} (W)	δ(mW/°C)	τ (Sec.)	T _L ~T _U (°C)
SCK301R0□	1	30	0.016	1500	8.0	Approx. 40	Approx. 190	-40 ~ +200
SCK301R5□	1.5	25	0.020					
SCK302R0□	2	23	0.022					
SCK302R5□	2.5	18	0.030					
SCK303R0□	3	17	0.035					
SCK304R0□	4	16	0.048					
SCK304R7□	4.7	15	0.055					
SCK305R0□	5	14	0.057					
SCK306R8□	6.8	12	0.077					
SCK307R0□	7	11.5	0.084					
SCK308R0□	8	10.5	0.100					
SCK30100□	10	10	0.115					
SCK30120□	12	9	0.142					
SCK30150□	15	8	0.175					
SCK30180□	18	7	0.210					
SCK30200□	20	6	0.233					

Note 1: □ = Tolerance of R₂₅

Note 2: Special specifications are available upon request.

NTC Thermistor : SCK Series

Power Thermistor for Limiting Inrush Current

■ Safety Approvals

- UL&cUL File No: E138827
- CSA File No: 97495
- TUV File No: R 50050155
- CQC File No: CQC05001011984,993,985,942,943,944, CQC05001011988,989,990,963,964,965

Body Size	Certified Model No.	Safety Approvals				
		UL	cUL	CSA	TUV	CQC
5mm	SCK-052	√	√	√	√	√
	SCK-081	√	√		√	√
	SCK-101	√	√	√	√	√
	SCK-121	√	√		√	√
	SCK-20X3	√	√	√	√	√
8mm	SCK-042	√	√	√	√	√
	SCK-4R72	√	√	√	√	√
	SCK-053	√	√	√	√	√
	SCK-063	√	√	√	√	√
	SCK-073	√	√		√	√
	SCK-082	√	√	√	√	√
	SCK-102	√	√	√	√	√
	SCK-152	√	√	√	√	√
	SCK-201	√	√	√	√	√
	SCK-30X	√	√	√	√	√
10mm	SCK-015	√	√		√	√
	SCK-1R35	√	√		√	√
	SCK-1R55	√	√		√	√
	SCK-2R55A	√	√	√	√	√
	SCK-035	√	√	√	√	√
	SCK-044	√	√	√	√	√
	SCK-054	√	√	√	√	√
	SCK-6R83	√	√	√	√	√
	SCK-083	√	√	√	√	√
	SCK-103	√	√	√	√	√
	SCK-123	√	√	√	√	√
	SCK-133	√	√	√	√	√
	SCK-152X	√	√	√	√	√
	SCK-162X	√	√	√	√	√
	SCK-202	√	√	√	√	√
	SCK-222	√	√		√	√
	SCK-252	√	√	√	√	√
	SCK-302	√	√	√	√	√
	SCK-472	√	√	√	√	√
	SCK-502	√	√	√	√	√
SCK-801	√	√	√	√	√	
SCK-1001	√	√	√	√	√	
SCK-1201	√	√	√	√	√	

Body Size	Certified Model No.	Safety Approvals				
		UL	cUL	CSA	TUV	CQC
13mm	SCK-013	√	√		√	√
	SCK-1R37	√	√		√	√
	SCK-2R56	√	√	√	√	√
	SCK-045	√	√		√	√
	SCK-4R74	√	√		√	√
	SCK-055	√	√	√	√	√
	SCK-074	√	√		√	√
	SCK-084	√	√	√	√	√
	SCK-104	√	√	√	√	√
	SCK-124	√	√	√	√	√
	SCK-153	√	√	√	√	√
	SCK-163	√	√	√	√	√
	SCK-183	√	√	√	√	√
	SCK-203	√	√	√	√	√
	SCK-0R78A	√	√		√	√
	SCK-018	√	√		√	
	SCK-1R38	√	√	√	√	√
	SCK-1R58	√	√	√	√	√
15mm	SCK-028	√	√		√	√
	SCK-2R58	√	√	√	√	√
	SCK-037	√	√	√	√	√
	SCK-046	√	√	√	√	√
	SCK-056	√	√	√	√	√
	SCK-065	√	√	√	√	√
	SCK-075	√	√	√	√	√
	SCK-085	√	√		√	√
	SCK-105	√	√	√	√	√
	SCK-125	√	√	√	√	√
	SCK-154	√	√	√	√	√
	SCK-164	√	√	√	√	√
	SCK-184	√	√	√	√	√
	SCK-204	√	√	√	√	√
	SCK-224	√	√		√	√
	SCK-253	√	√	√	√	√
	SCK-303	√	√	√	√	√
	SCK-333	√	√		√	√
	SCK-403	√	√	√	√	√
	SCK-473	√	√	√	√	√

NTC Thermistor : SCK Series

Power Thermistor for Limiting Inrush Current

Body Size	Certified Model No.	Safety Approvals			
		UL	cUL	TUV	CQC
20mm	SCK200R7	√	√	√	√
	SCK201R0	√	√	√	√
	SCK201R5	√	√	√	√
	SCK202R0	√	√	√	√
	SCK202R5	√	√	√	√
	SCK203R0	√	√	√	√
	SCK204R0	√	√	√	√
	SCK204R7	√	√	√	√
	SCK205R0	√	√	√	√
	SCK206R0	√	√	√	√
	SCK206R8	√	√	√	√
	SCK207R0	√	√	√	√
	SCK208R0	√	√	√	√
	SCK20100	√	√	√	√
	SCK20120	√	√	√	√
	SCK20130	√	√	√	√
	SCK20150	√	√	√	√
	SCK20160	√	√	√	√
	SCK20180	√	√	√	√
	SCK20200	√	√	√	√
25mm	SCK251R0	√	√	√	√
	SCK251R5	√	√	√	√
	SCK252R0	√	√	√	√
	SCK252R5	√	√	√	√
	SCK253R0	√	√	√	√
	SCK254R0	√	√	√	√
	SCK254R7	√	√	√	√
	SCK255R0	√	√	√	√
	SCK256R8	√	√	√	√
	SCK257R0	√	√	√	√
	SCK258R0	√	√	√	√
	SCK25100	√	√	√	√
	SCK25120	√	√	√	√
	SCK25150	√	√	√	√
	SCK25180	√	√	√	√
	SCK25200	√	√	√	√

Body Size	Certified Model No.	Safety Approvals			
		UL	cUL	TUV	CQC
30mm	SCK301R0	√	√	√	√
	SCK301R5	√	√	√	√
	SCK302R0	√	√	√	√
	SCK302R5	√	√	√	√
	SCK303R0	√	√	√	√
	SCK304R0	√	√	√	√
	SCK304R7	√	√	√	√
	SCK305R0	√	√	√	√
	SCK306R8	√	√	√	√
	SCK307R0	√	√	√	√
	SCK308R0	√	√	√	√
	SCK30100	√	√	√	√
	SCK30120	√	√	√	√
	SCK30150	√	√	√	√
	SCK30180	√	√	√	√
	SCK30200	√	√	√	√

NTC Thermistor : SCK Series

Power Thermistor for Limiting Inrush Current

■ Max. Current Derating Curve

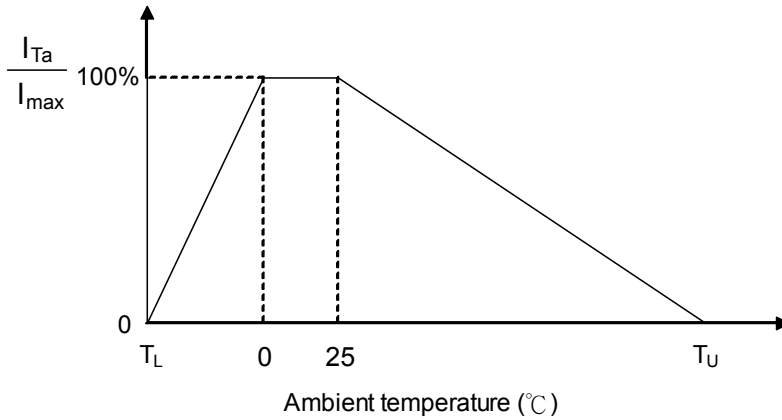

T_U : Maximum operating temperature ($^{\circ}\text{C}$)

T_L : Minimum operating temperature ($^{\circ}\text{C}$)

For example:

Ambient temperature(T_a) = 60 $^{\circ}\text{C}$

Maximum operating temperature(T_U) = 200 $^{\circ}\text{C}$

$$I_{Ta} = [1 - (T_a - 25) / (T_U - 25)] \times I_{max} = 80\% I_{max}$$

■ R-T Characteristic Curves

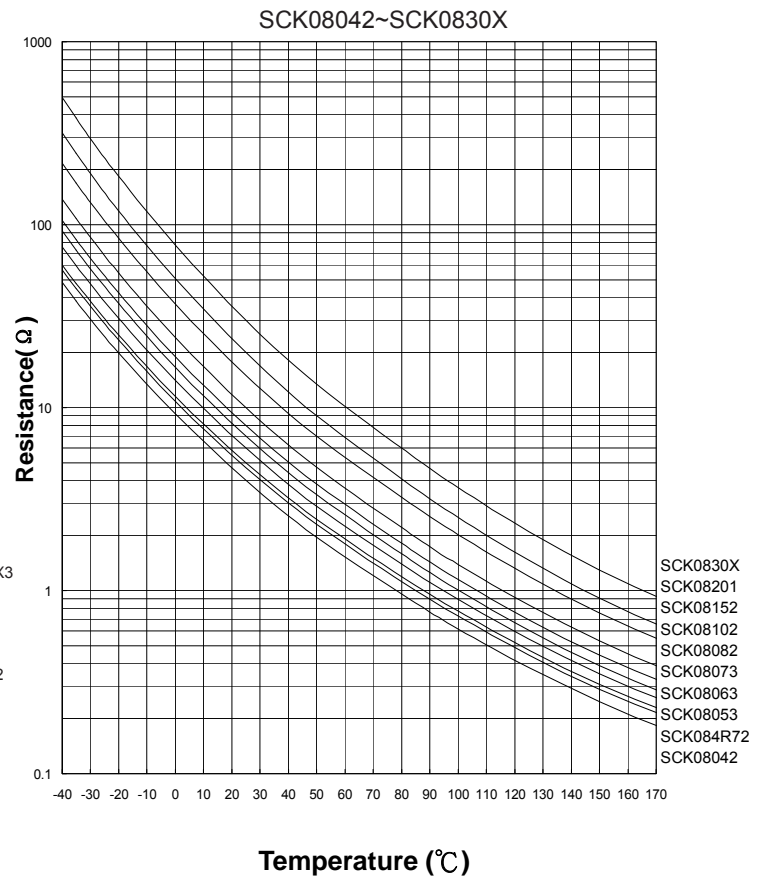
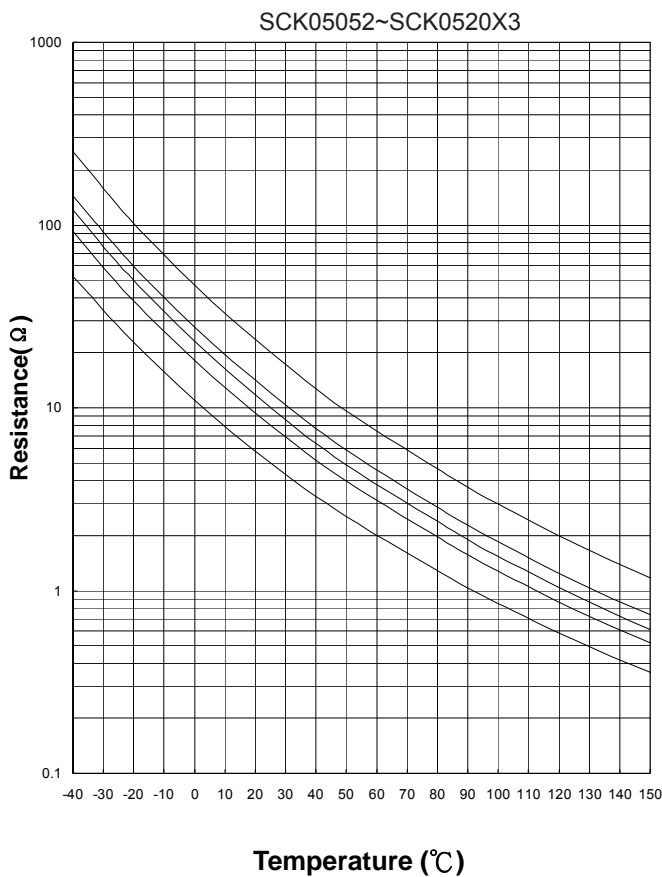

NTC Thermistor : SCK Series

Power Thermistor for Limiting Inrush Current

■ R-T Characteristic Curves

SCK10015~SCK101201

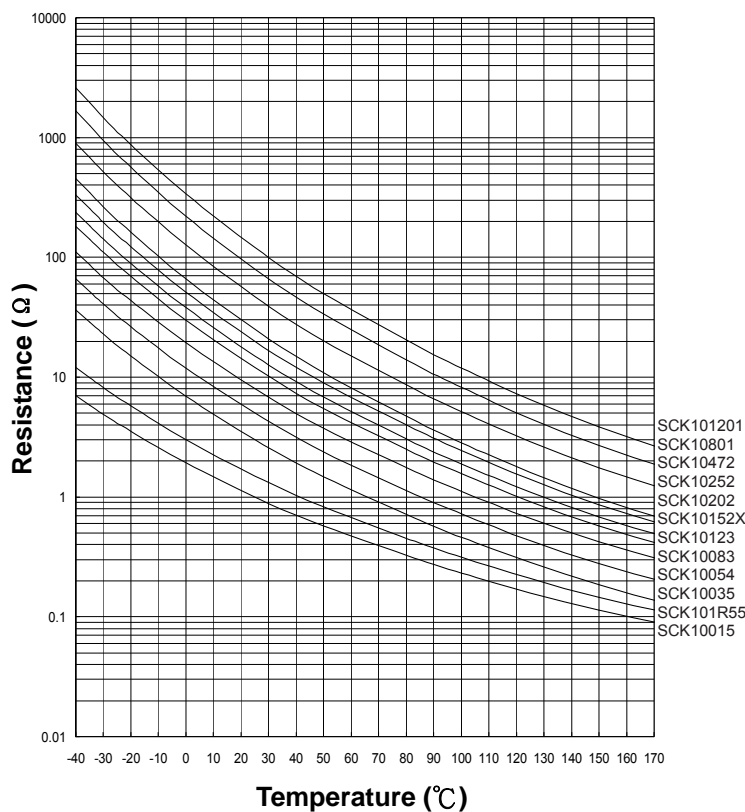

SCK101R35~SCK101001

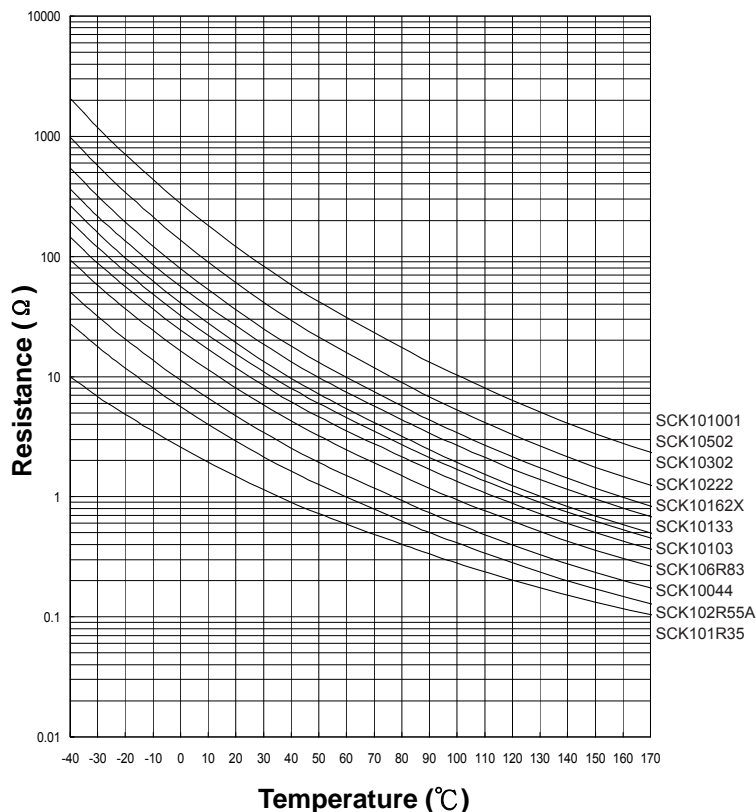

SCK13013~SCK13183

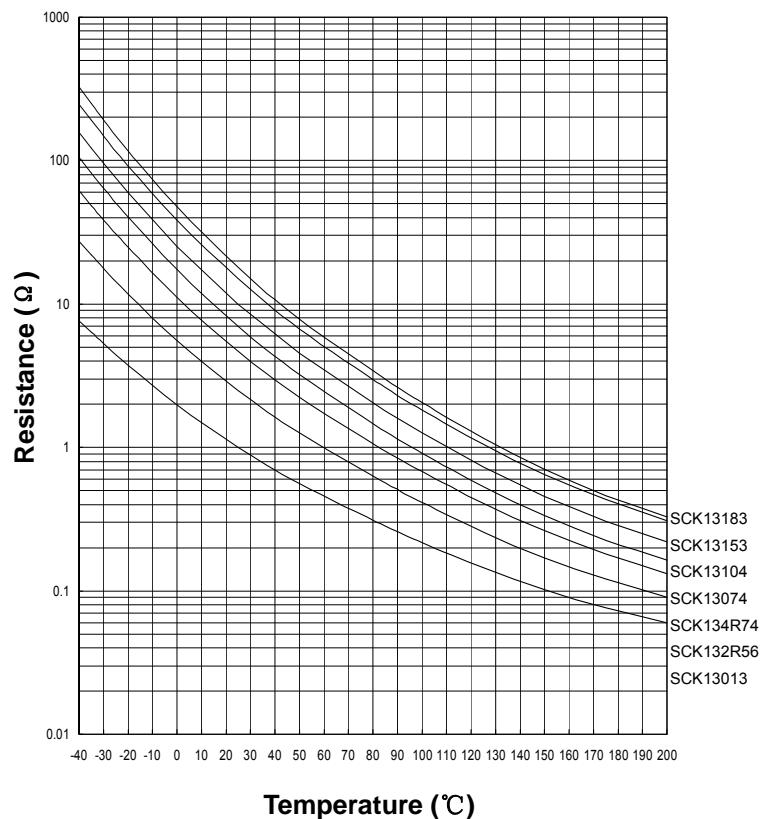

SCK131R37~SCK13203

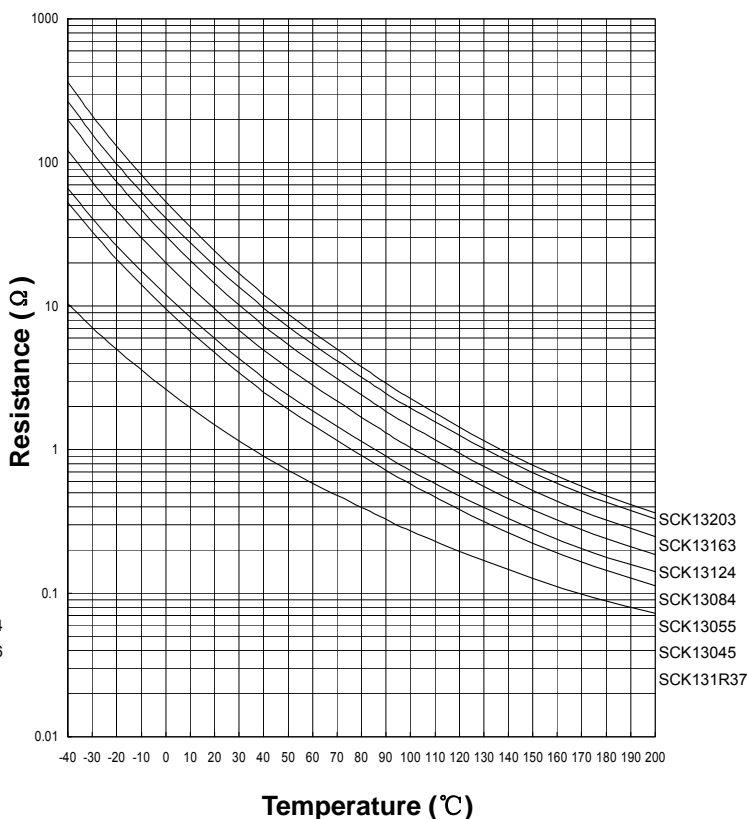

NTC Thermistor : SCK Series

Power Thermistor for Limiting Inrush Current

■ R-T Characteristic Curves

SCK150R78A~SCK151202

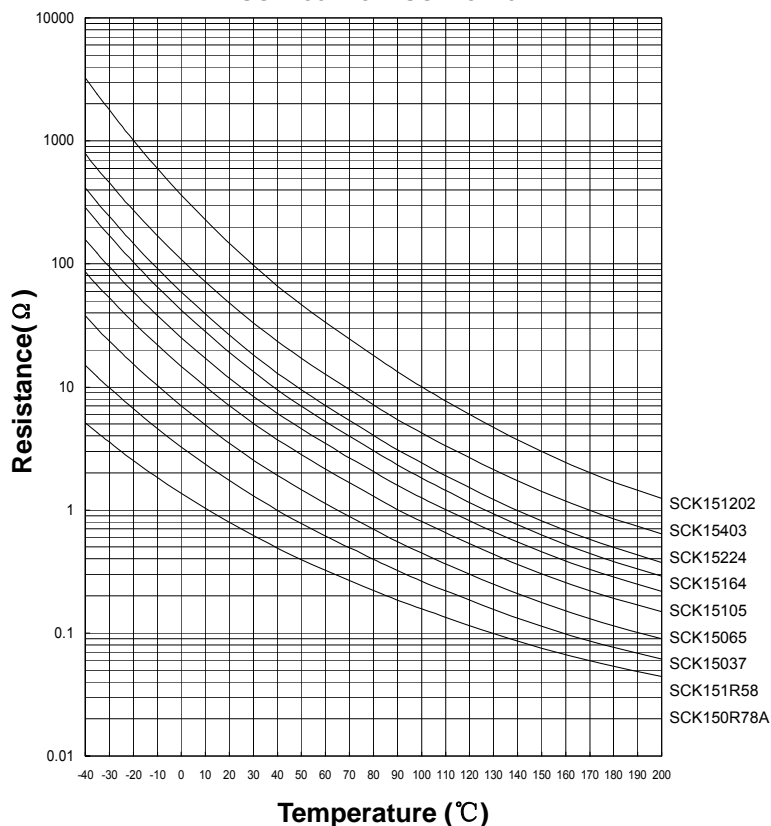

SCK15016~SCK15473

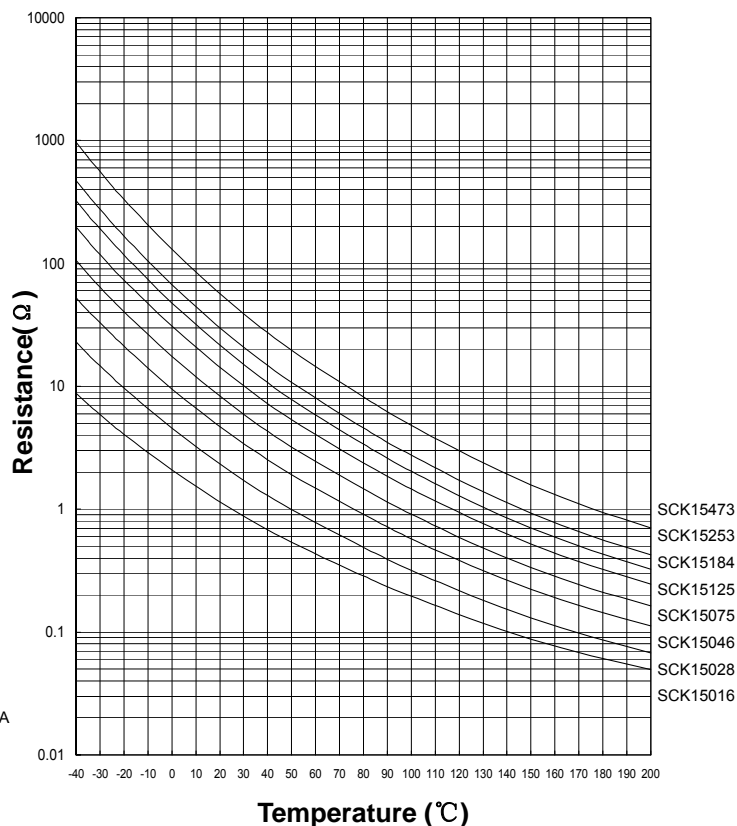

SCK151R38~SCK15802X

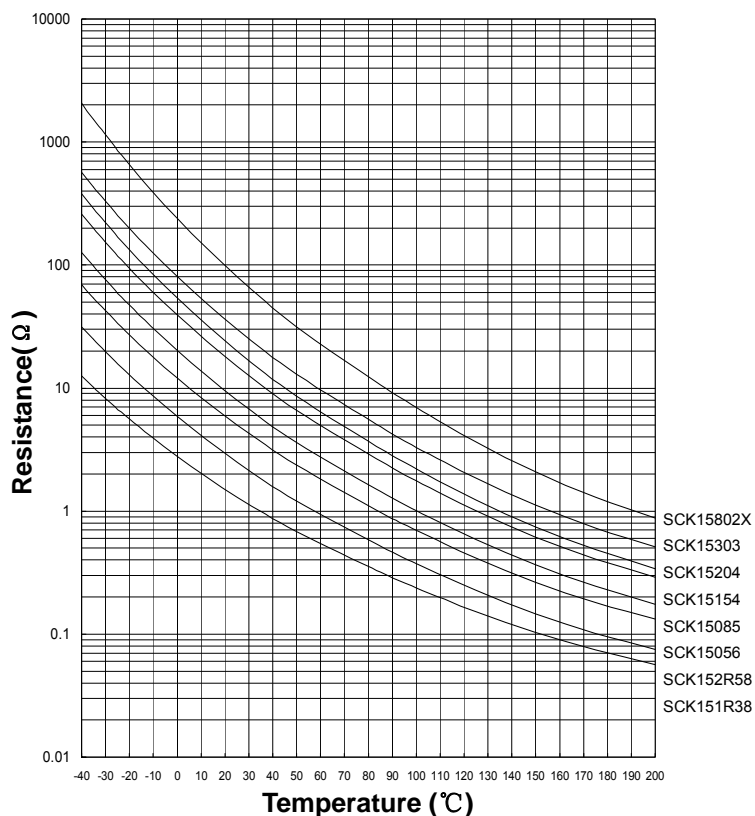

SCK200R7~SCK20180

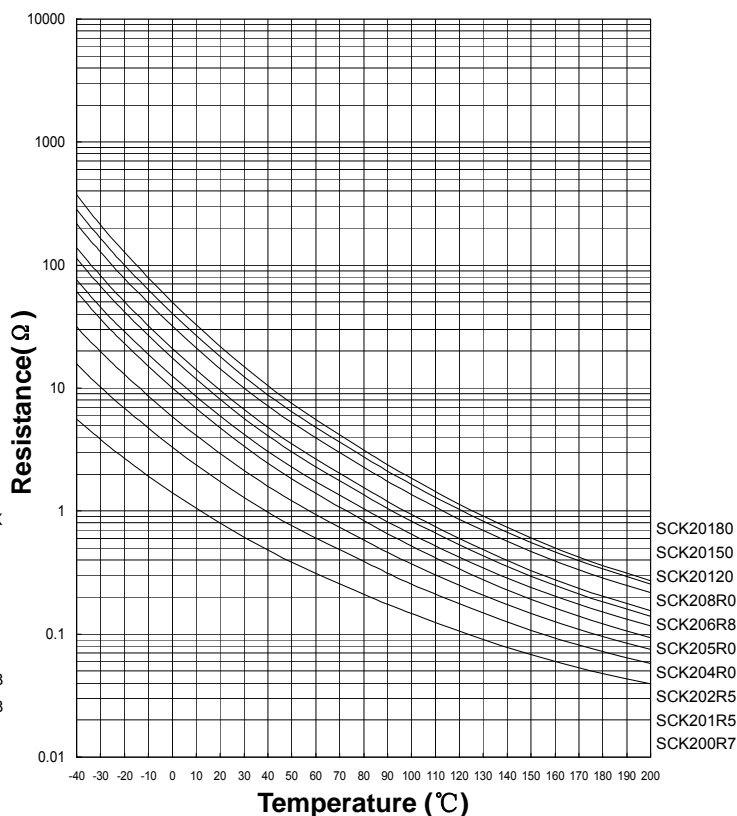

NTC Thermistor : SCK Series

Power Thermistor for Limiting Inrush Current

■ R-T Characteristic Curves

SCK201R0~SCK20200

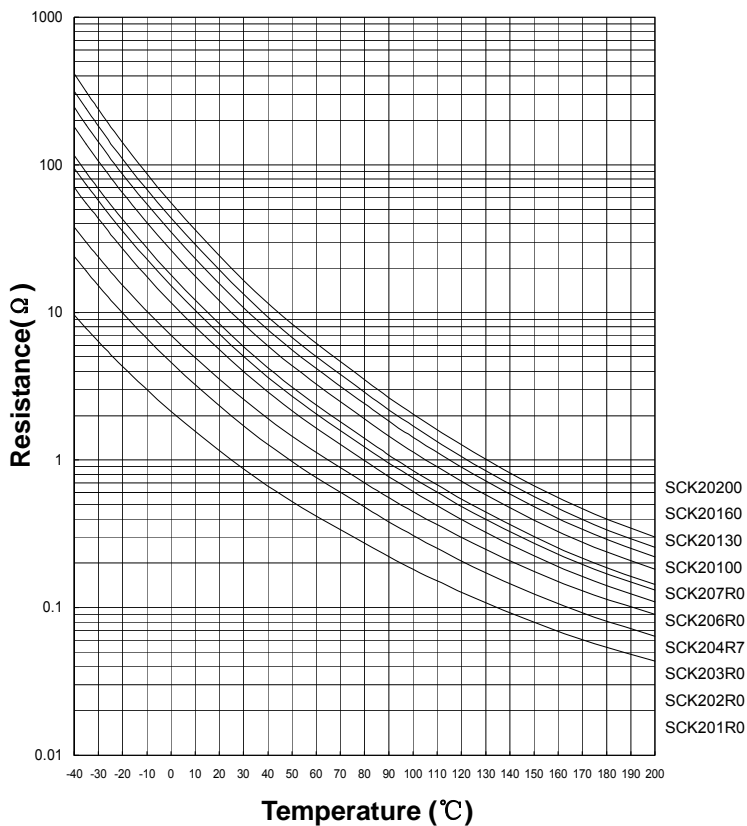

SCK251R0~SCK25180

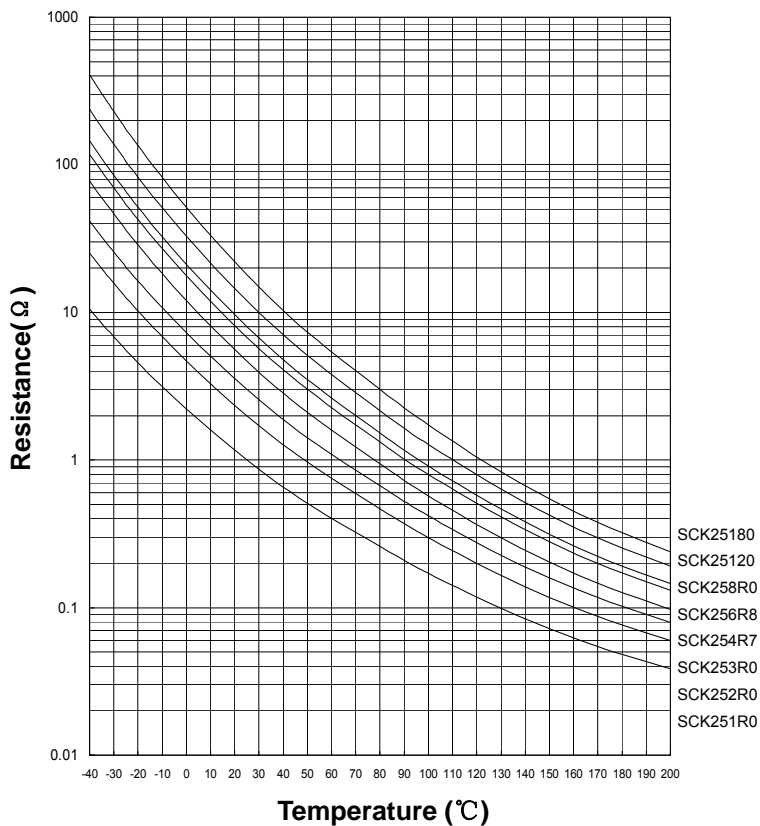

SCK251R5~SCK25200

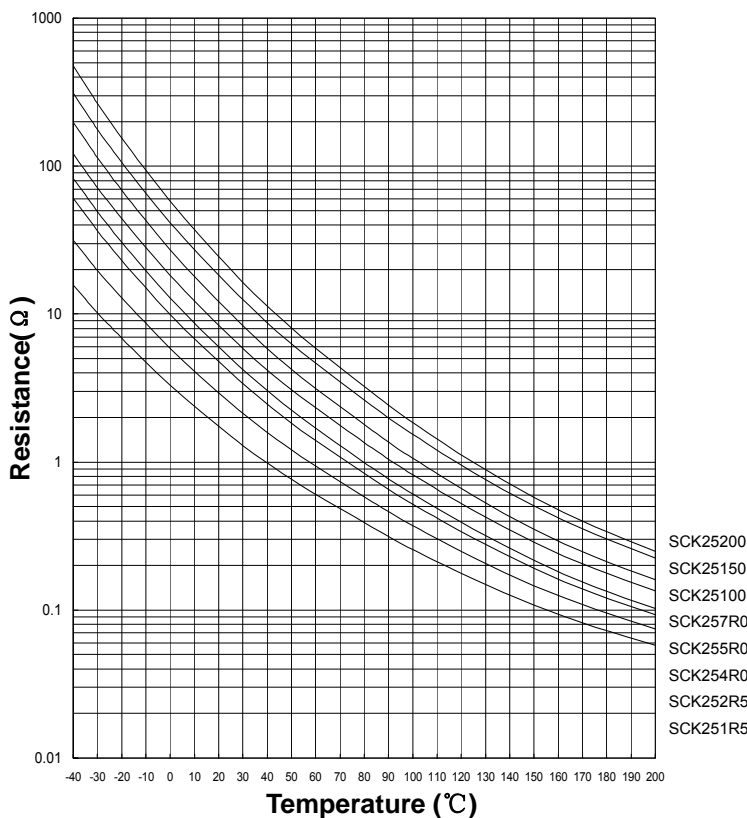

SCK301R0~SCK30180

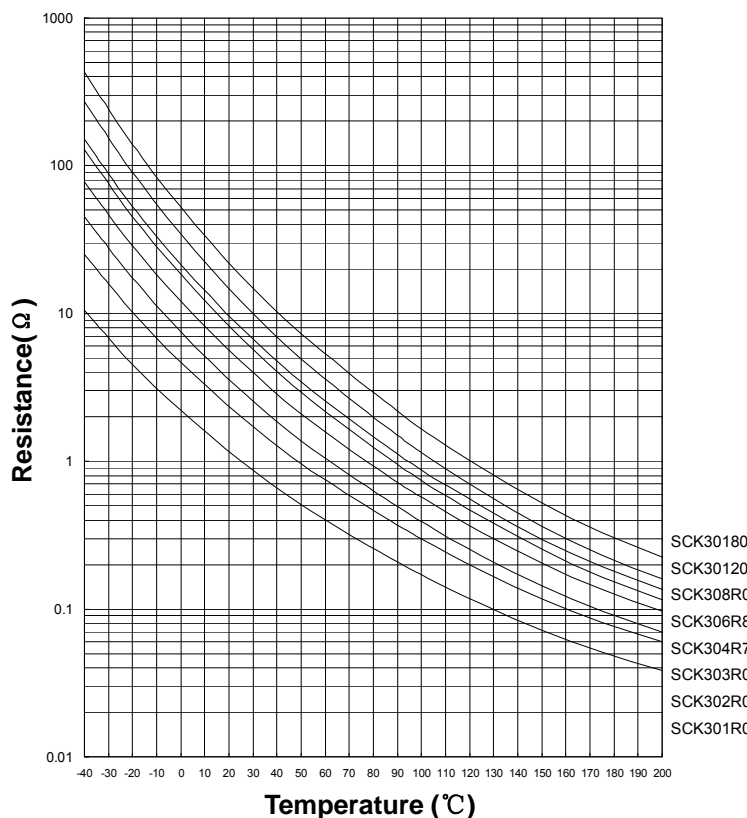

NTC Thermistor : SCK Series

Power Thermistor for Limiting Inrush Current

■ R-T Characteristic Curves

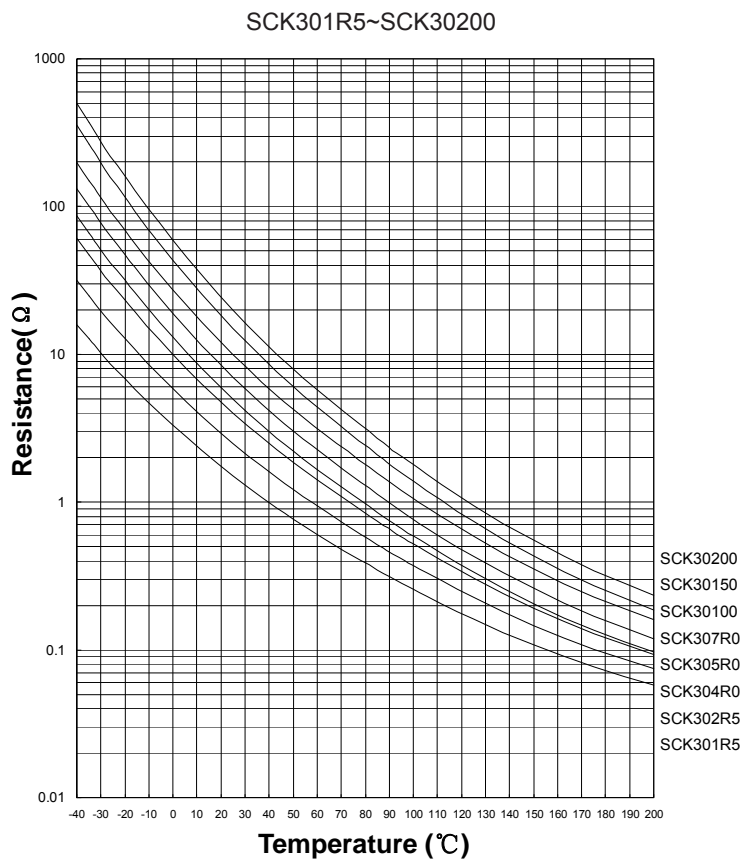

NTC Thermistor : SCK Series

Power Thermistor for Limiting Inrush Current

■ V-I Characteristic Curves (representative)

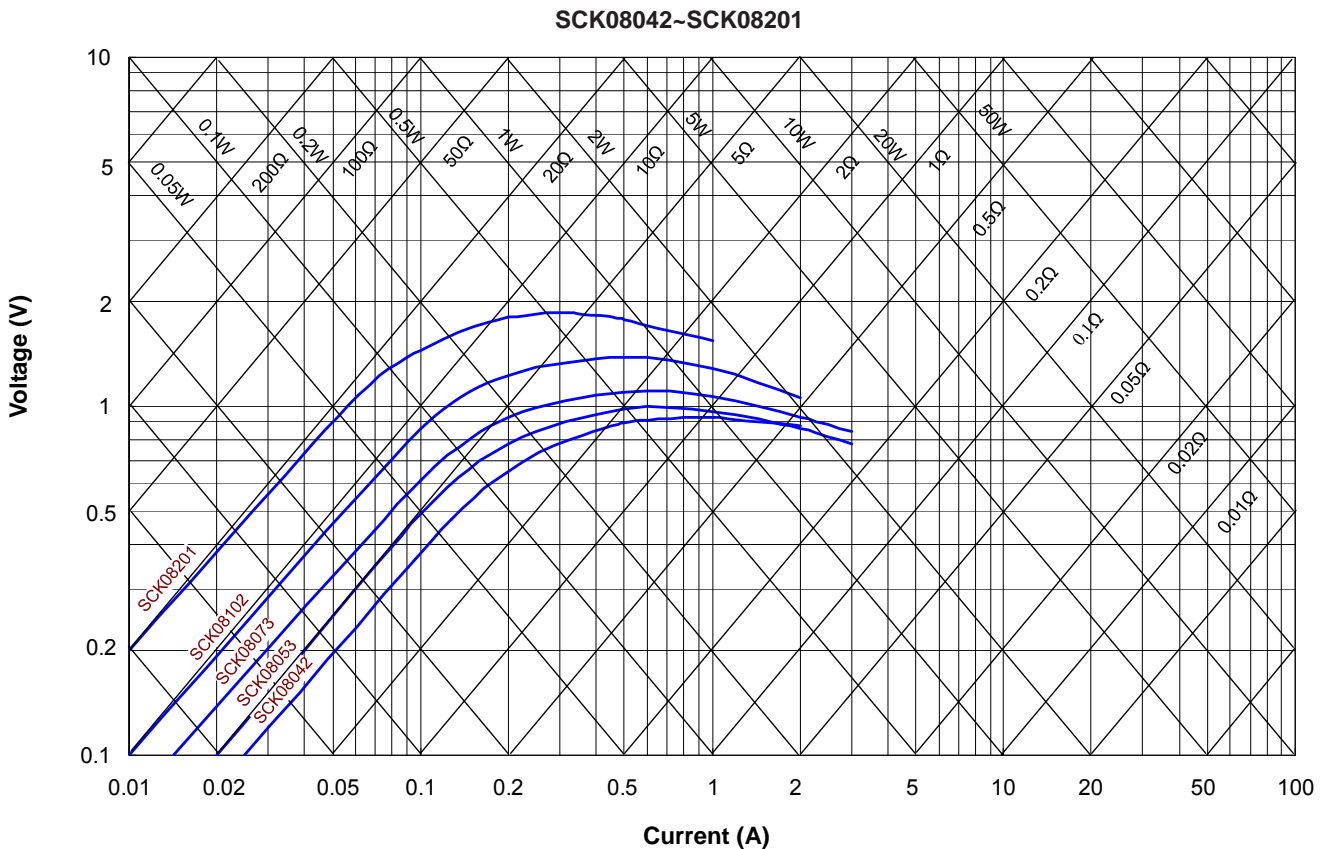
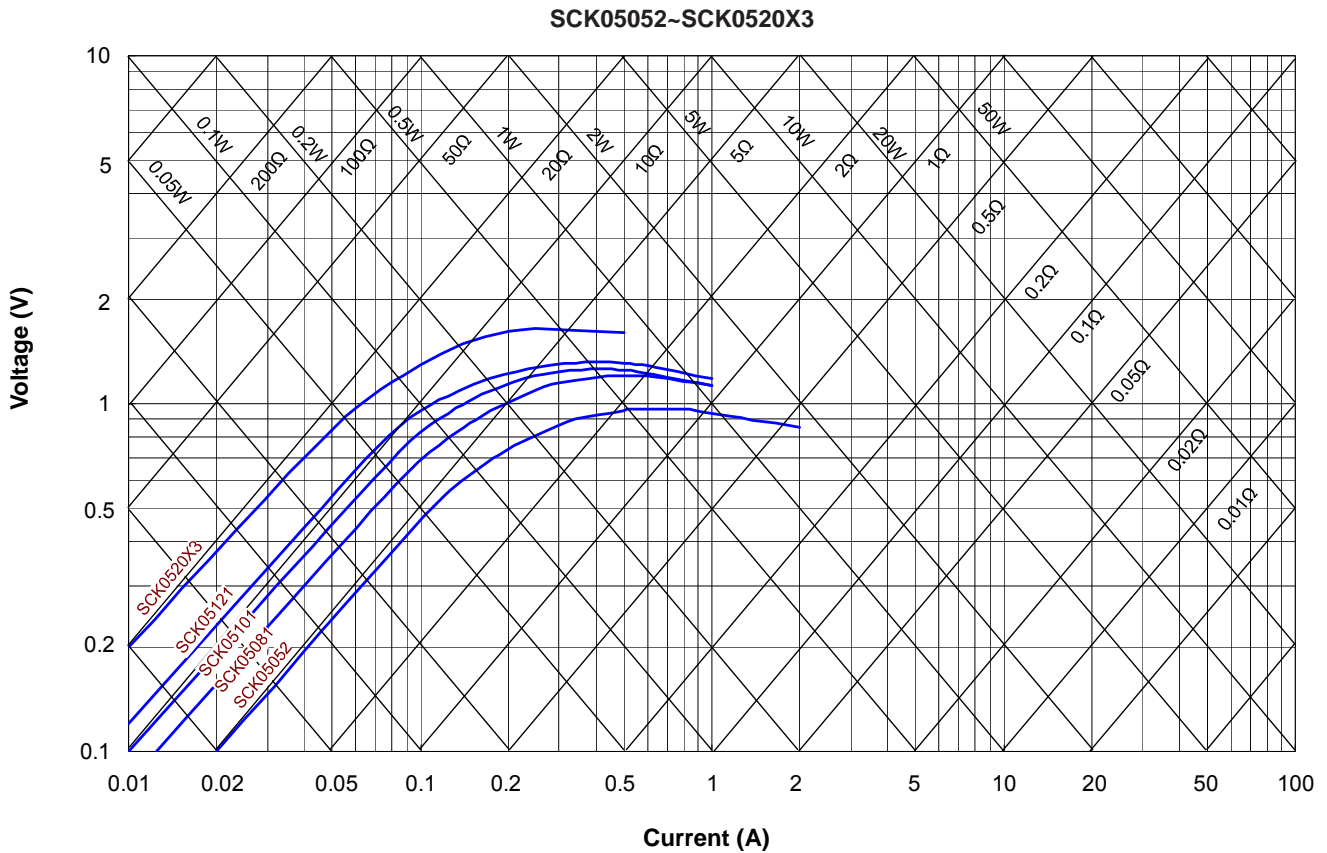

NTC Thermistor : SCK Series

Power Thermistor for Limiting Inrush Current

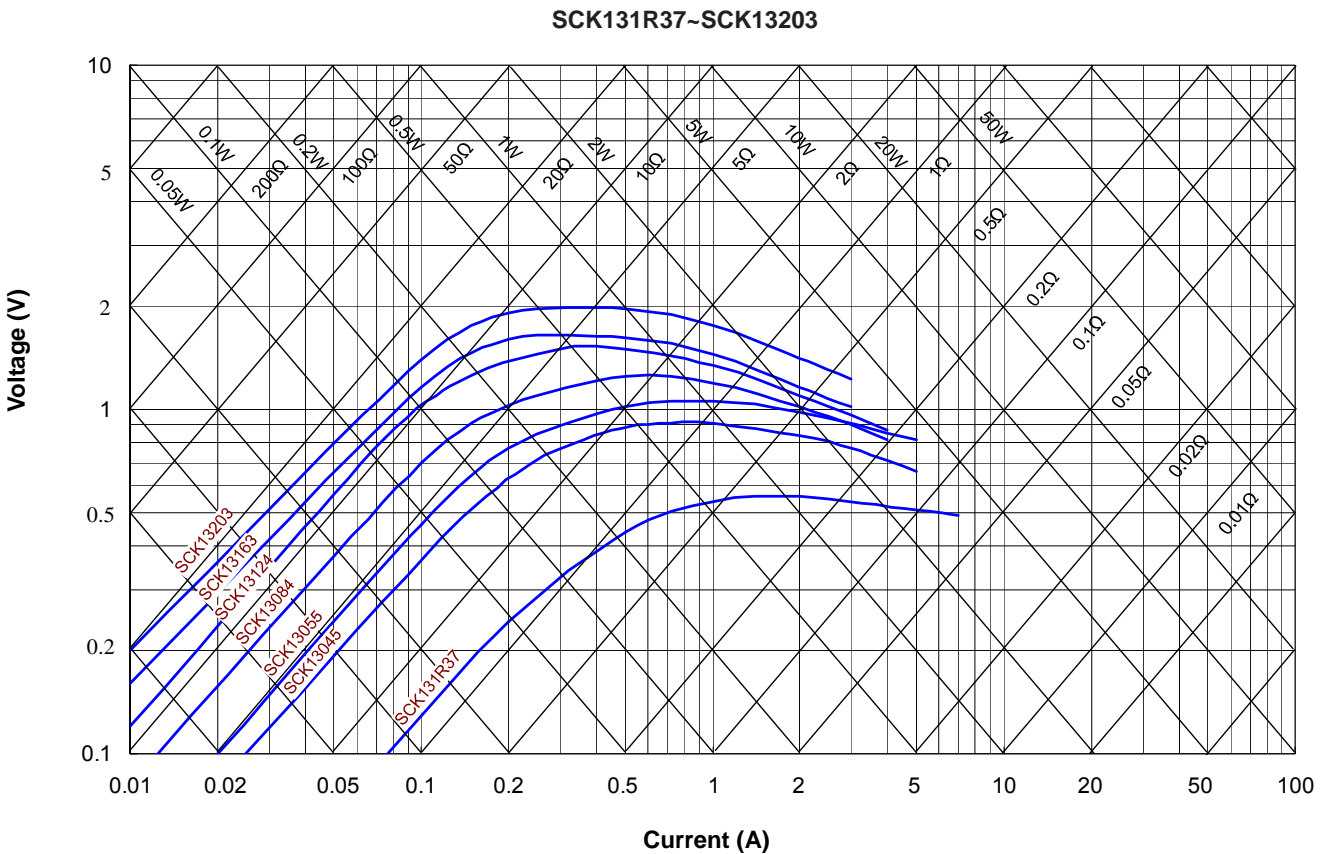
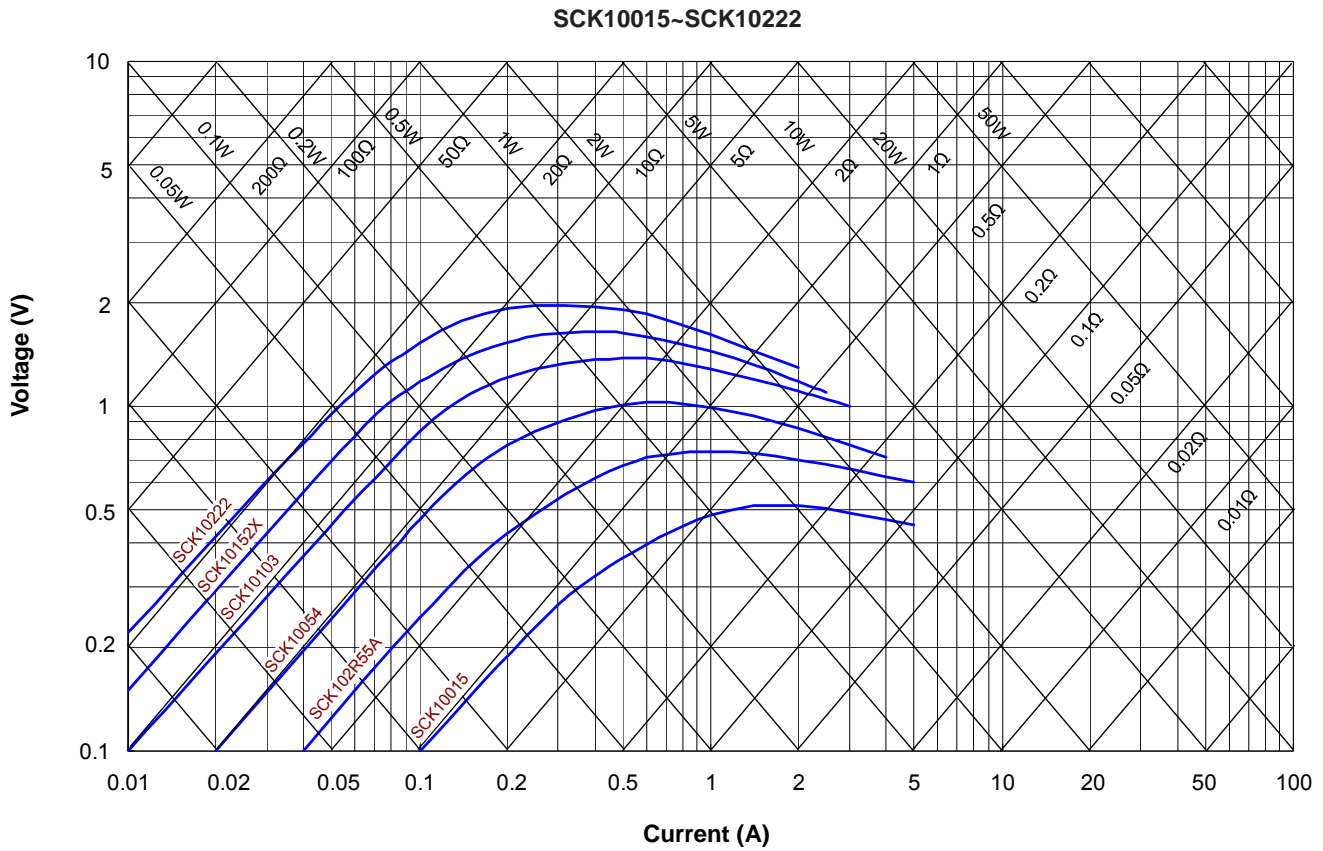

NTC Thermistor : SCK Series

Power Thermistor for Limiting Inrush Current

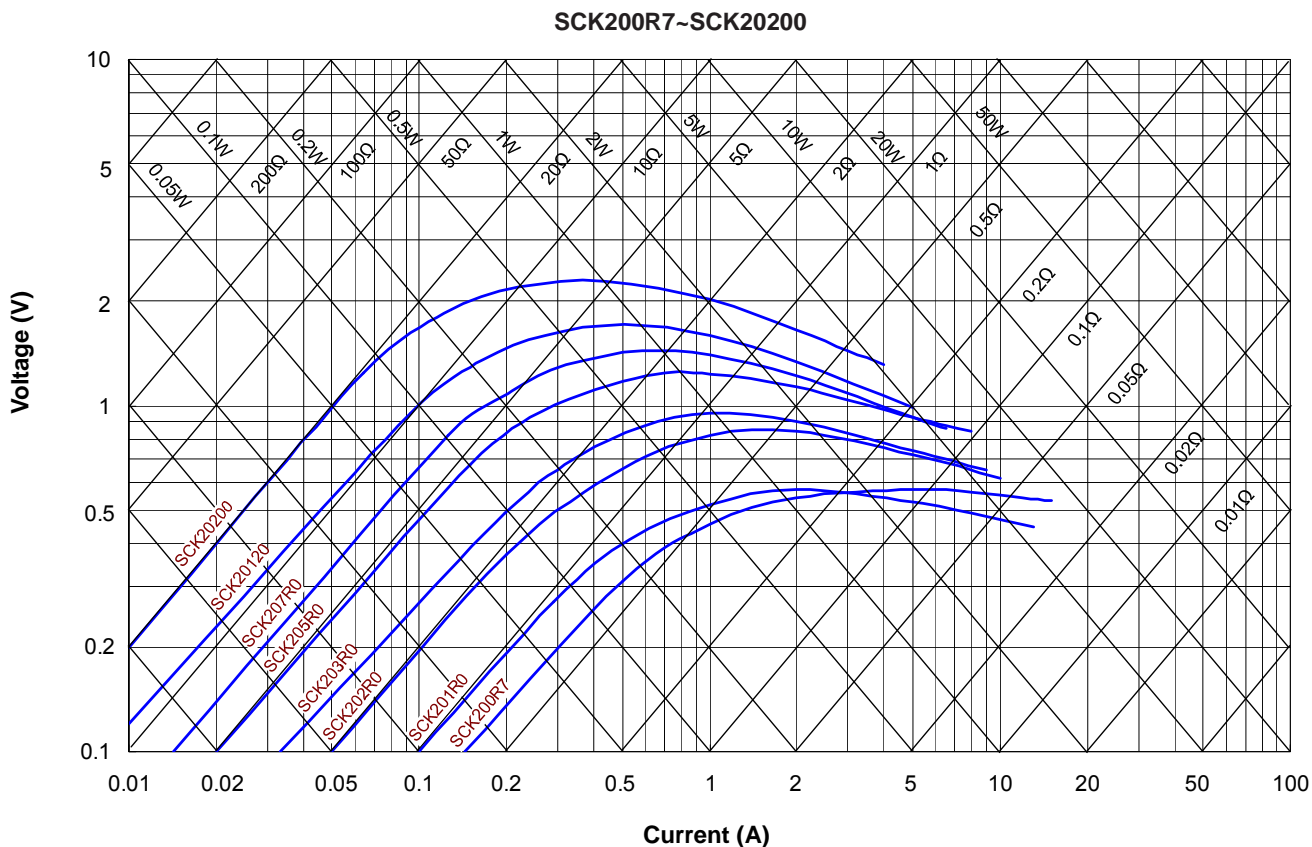
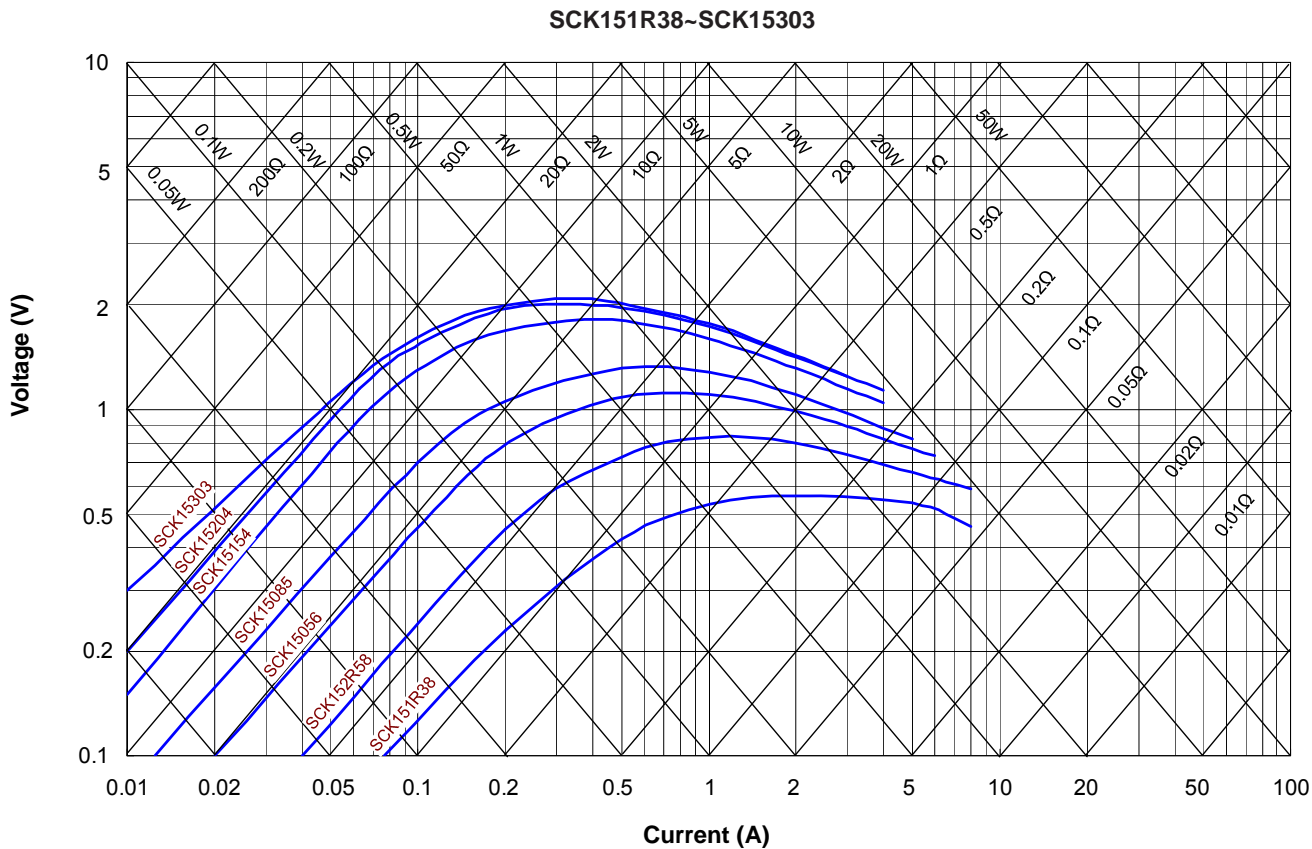

NTC Thermistor : SCK Series

Power Thermistor for Limiting Inrush Current

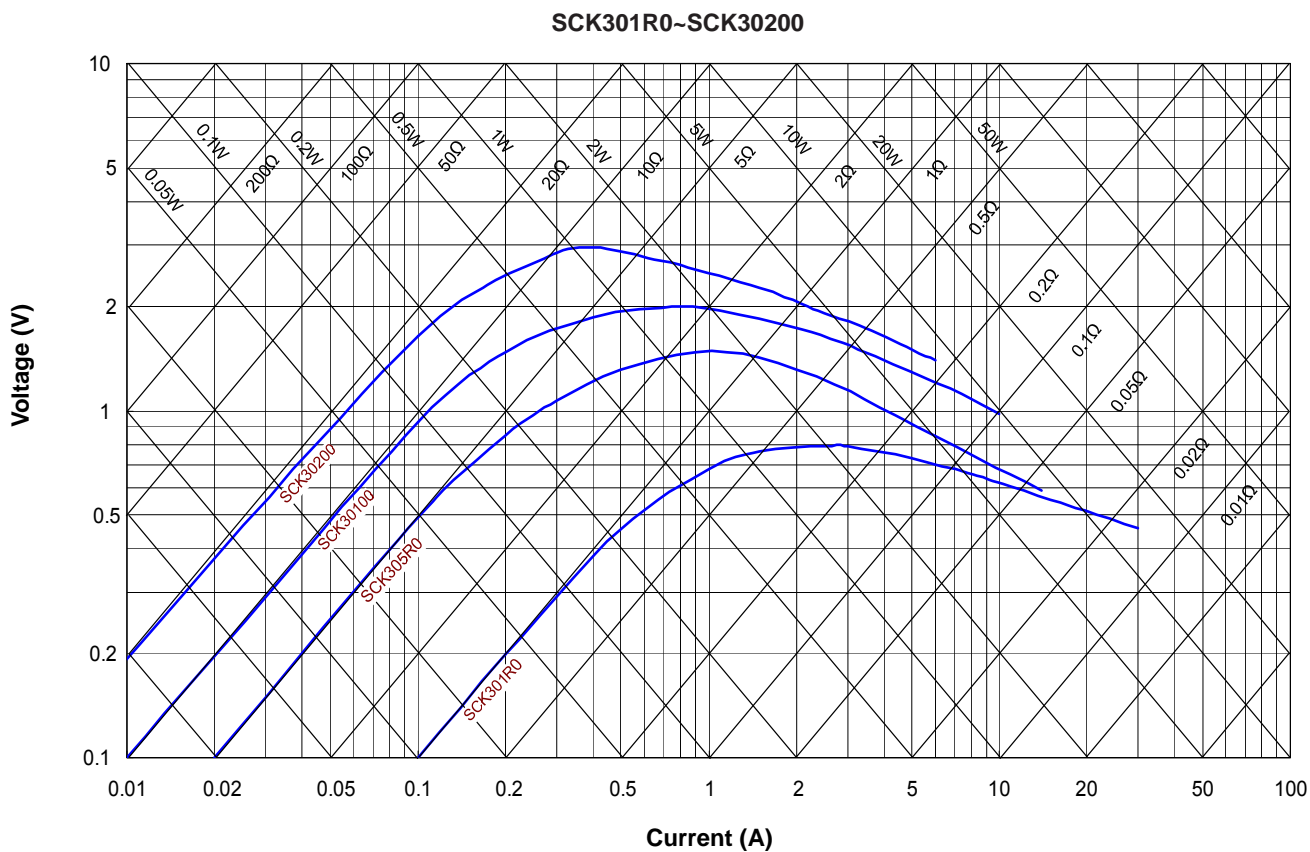
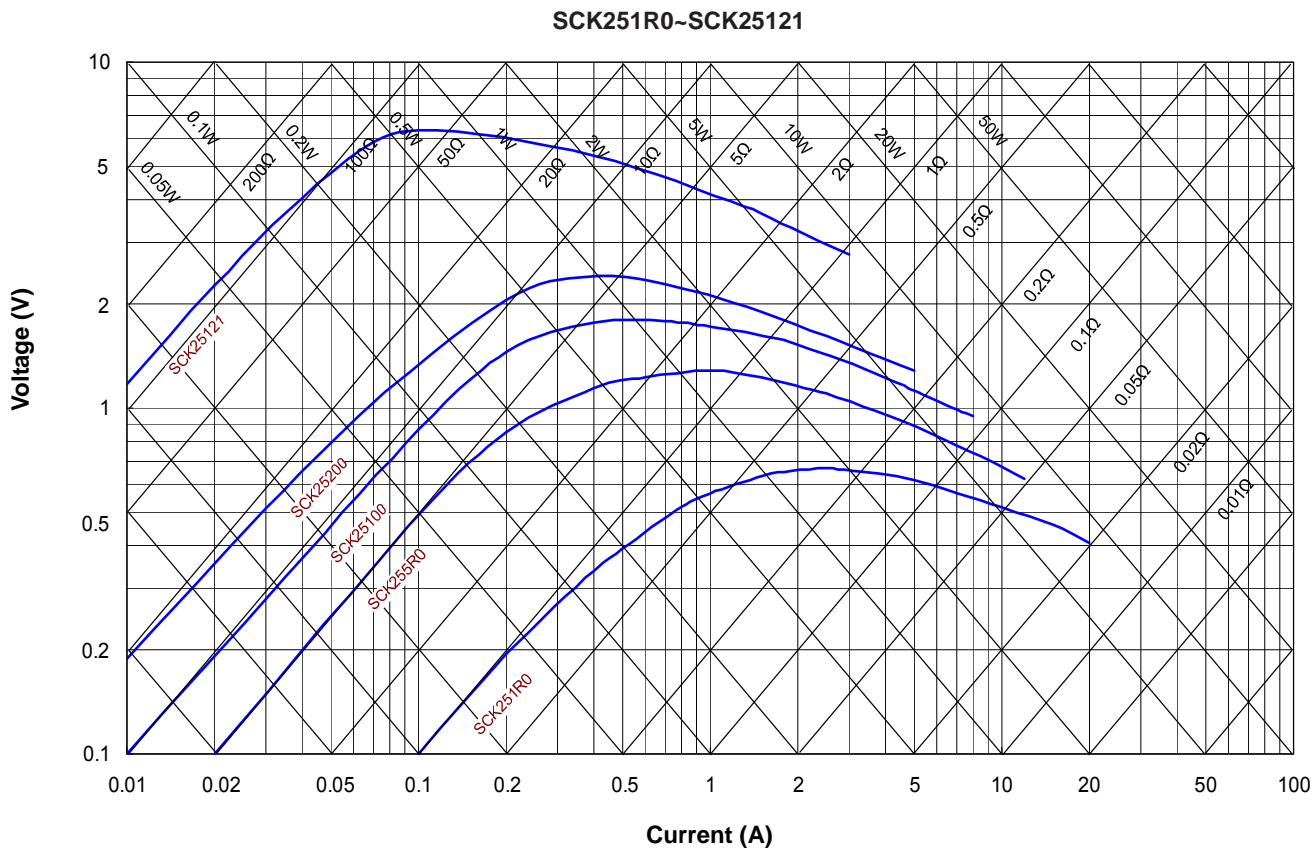

NTC Thermistor : SCK Series

Power Thermistor for Limiting Inrush Current

■ Soldering Recommendation

● Wave Soldering Profile

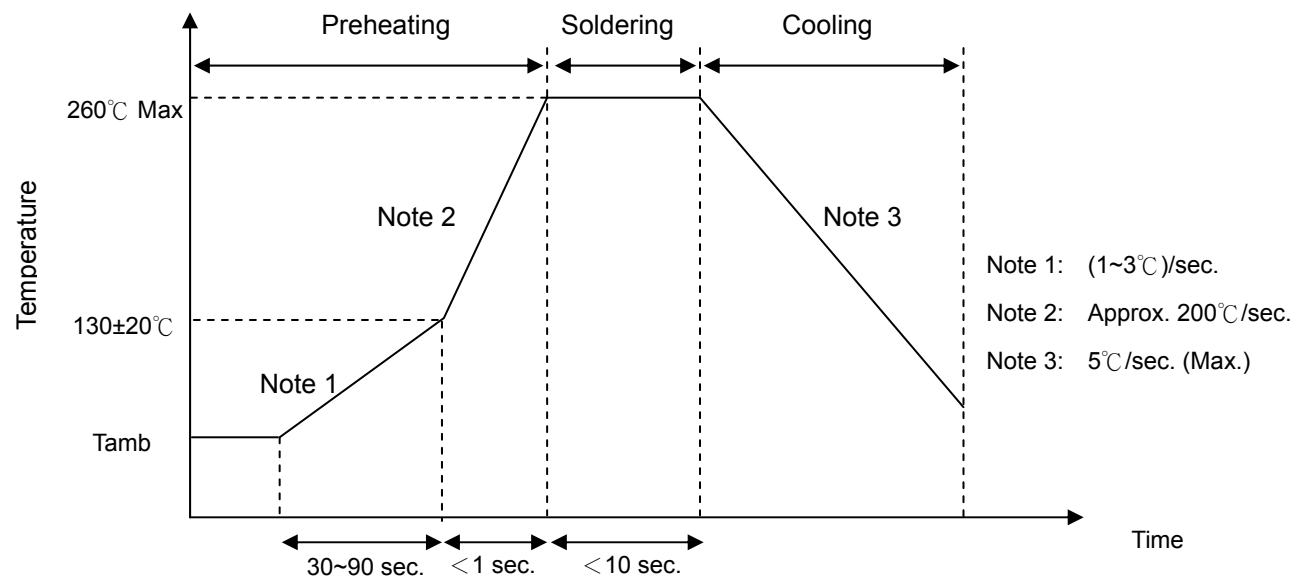

● Recommended Reworking Conditions with Soldering Iron

Item	Condition
Temperature of Soldering Iron-tip	360°C (max.)
Soldering Time	3 sec. (max.)
Distance from Thermistor	2 mm (min.)

NTC Thermistor : SCK Series

Power Thermistor for Limiting Inrush Current

■ Reliability

Item	Standard	Test conditions / Methods	Specifications															
Tensile Strength of Terminals	IEC 60068-2-21	Gradually apply the specified force and keep the unit fixed for 10±1 sec. <table style="width: 100%; border-collapse: collapse;"> <tr> <td style="text-align: center; width: 50%;">Terminal diameter (mm)</td> <td style="text-align: center; width: 50%;">Force (Kg)</td> </tr> <tr> <td style="text-align: center; border-top: 1px solid black;">0.5<d≤0.80</td> <td style="text-align: center; border-top: 1px solid black;">1.0</td> </tr> <tr> <td style="text-align: center;">0.8<d≤1.25</td> <td style="text-align: center;">2.0</td> </tr> </table>	Terminal diameter (mm)	Force (Kg)	0.5<d≤0.80	1.0	0.8<d≤1.25	2.0	No visible damage									
Terminal diameter (mm)	Force (Kg)																	
0.5<d≤0.80	1.0																	
0.8<d≤1.25	2.0																	
Solderability	IEC 60068-2-20	245 ±3°C, 3 ± 0.3 sec.	At least 95% of terminal electrode is covered by new solder															
Resistance to Soldering Heat	IEC 60068-2-20	260 ± 3°C, 10 ± 1 sec.	No visible damage ΔR ₂₅ /R ₂₅ ≤ 10 %															
High Temperature Storage	IEC 60068-2-2	T _U ± 5 °C , 1000± 24 hrs	No visible damage ΔR ₂₅ /R ₂₅ ≤ 20 %															
Damp Heat, Steady State	IEC 60068-2-78	40 ± 2°C, 90~95% RH, 1000 ± 24 hrs	No visible damage ΔR ₂₅ /R ₂₅ ≤ 20 %															
Rapid Change of Temperature	IEC 60068-2-14	The conditions shown below shall be repeated 5 cycles. <table border="1" style="width: 100%; border-collapse: collapse; text-align: center;"> <thead> <tr> <th>Step</th> <th>Temperature (°C)</th> <th>Period (minutes)</th> </tr> </thead> <tbody> <tr> <td>1</td> <td>T_L ± 5</td> <td>30 ± 3</td> </tr> <tr> <td>2</td> <td>Room temperature</td> <td>5 ± 3</td> </tr> <tr> <td>3</td> <td>T_U ± 5</td> <td>30 ± 3</td> </tr> <tr> <td>4</td> <td>Room temperature</td> <td>5 ± 3</td> </tr> </tbody> </table>	Step	Temperature (°C)	Period (minutes)	1	T _L ± 5	30 ± 3	2	Room temperature	5 ± 3	3	T _U ± 5	30 ± 3	4	Room temperature	5 ± 3	No visible damage ΔR ₂₅ /R ₂₅ ≤ 20 %
Step	Temperature (°C)	Period (minutes)																
1	T _L ± 5	30 ± 3																
2	Room temperature	5 ± 3																
3	T _U ± 5	30 ± 3																
4	Room temperature	5 ± 3																
Max. Current	IEC 60539-1	25 ± 5°C, I _{max.} , 1000± 24 hrs	No visible damage ΔR ₂₅ /R ₂₅ ≤ 20 %															
Endurance	Specification Standard	25 ± 5°C, I _{max.} , C _{th} , 1min ON / 5 mins OFF x 1000 cycles C _{th} = Capacitance at 240 Vac	No visible damage ΔR ₂₅ /R ₂₅ ≤ 20 %															
Insulation Test	MIL-STD-202F -Method 302	1000 V _{DC} , 1 min	No visible damage ≥ 500 MΩ															

NTC Thermistor : SCK Series

Power Thermistor for Limiting Inrush Current

■ Packaging

● Taping Specification

S (Straight lead) Type

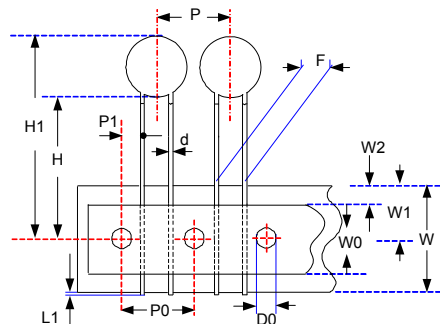

Figure A

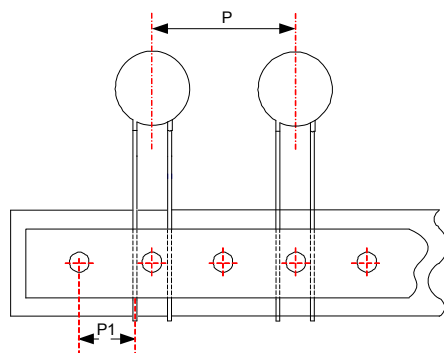

Figure B

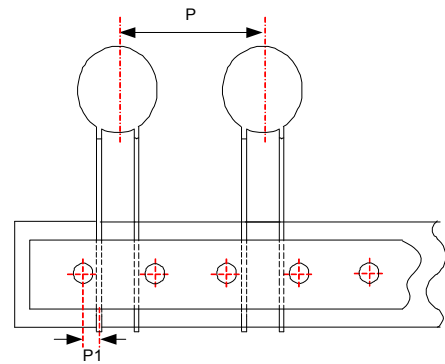
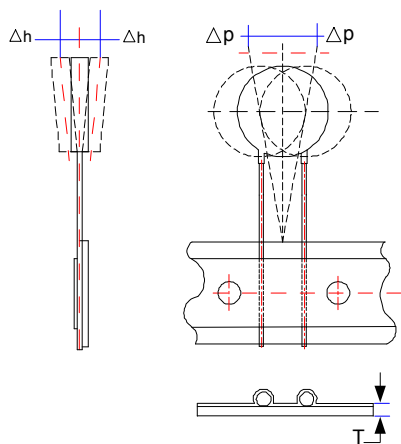

Figure C



(Unit: mm)

Taping Dimension	Disc Size	P ₀	F	P	P ₁	H	H ₁	d	W ₀	W ₁	W ₂	W	△P	△h	L ₁	D ₀	T	Figure
		±0.3	±1	±1	±0.7	+2/-0	Max.	±0.02	±1	+0.75 /-0.5	Max.	+1/ -0.5	Max.	Max.	Max.	±0.2	±0.2	
P ₀ :12.7	05	12.7	4.0	12.7	4.35	18	28	0.8	12	9	3	18	1	2	0.5	4	0.6	A
	08	12.7	5.0	12.7	3.85	18	30	0.8	12	9	3	18	1	2	0.5	4	0.6	A
	10	12.7	5.0	12.7	3.85	18	32	0.8	12	9	3	18	1	2	0.5	4	0.6	A
	13	12.7	7.5	25.4	8.95	18	35	0.8	12	9	3	18	1	2	0.5	4	0.6	B
	15	12.7	7.5	25.4	8.95	18	37	1.0	12	9	3	18	1	2	0.5	4	0.6	B
	20	12.7	7.5	25.4	8.95	18	42	1.0	12	9	3	18	1	2	0.5	4	0.6	B
P ₀ :15.0	05	15.0	4.0	15.0	5.50	18	28	0.8	12	9	3	18	1	2	0.5	4	0.6	A
	08	15.0	5.0	15.0	5.00	18	30	0.8	12	9	3	18	1	2	0.5	4	0.6	A
	10	15.0	5.0	15.0	5.00	18	32	0.8	12	9	3	18	1	2	0.5	4	0.6	A
	13	15.0	7.5	30.0	3.75	18	35	0.8	12	9	3	18	1	2	0.5	4	0.6	C
	15	15.0	7.5	30.0	3.75	18	37	1.0	12	9	3	18	1	2	0.5	4	0.6	C
	20	15.0	7.5	30.0	3.75	18	42	1.0	12	9	3	18	1	2	0.5	4	0.6	C

NTC Thermistor : SCK Series

Power Thermistor for Limiting Inrush Current

F Kink Type

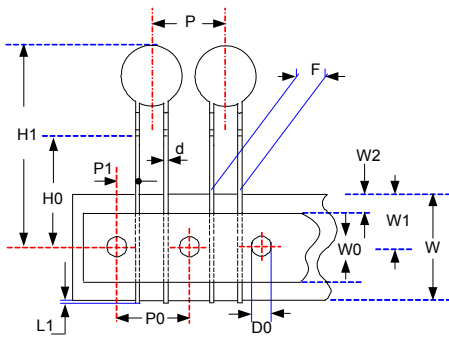

Figure A

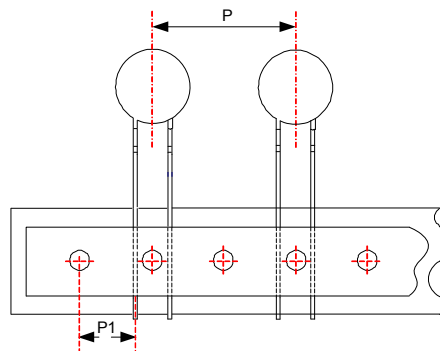

Figure B

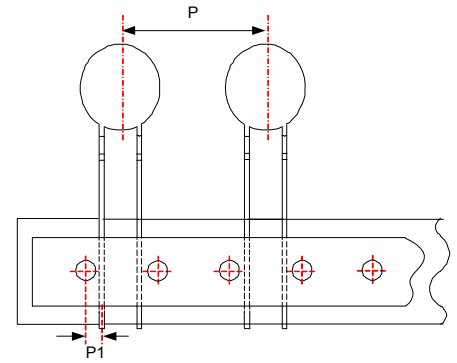
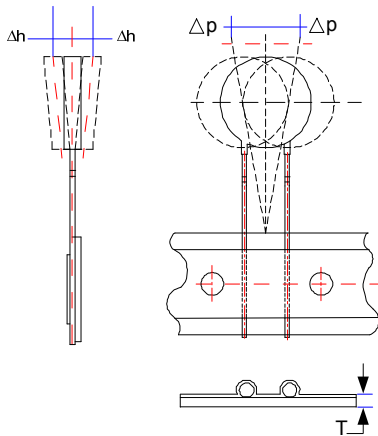

Figure C



(Unit: mm)

Taping Dimension	Disc Size	P ₀	F	P	P ₁	H ₀	H ₁	d	W ₀	W ₁	W ₂	W	ΔP	Δh	L ₁	D ₀	T	Figure
		±0.3	±1	±1	±0.7	±0.5	Max.	±0.02	±1	+0.75 /-0.5	Max.	+1/ -0.5	Max.	Max.	Max.	±0.2	±0.2	
P ₀ :12.7	05	12.7	4.0	12.7	4.35	16	28	0.8	12	9	3	18	1	2	0.5	4	0.6	A
	08	12.7	5.0	12.7	3.85	16	30	0.8	12	9	3	18	1	2	0.5	4	0.6	A
	10	12.7	5.0	12.7	3.85	16	32	0.8	12	9	3	18	1	2	0.5	4	0.6	A
	13	12.7	7.5	25.4	8.95	16	35	0.8	12	9	3	18	1	2	0.5	4	0.6	B
	15	12.7	7.5	25.4	8.95	16	37	1.0	12	9	3	18	1	2	0.5	4	0.6	B
	20	12.7	7.5	25.4	8.95	16	42	1.0	12	9	3	18	1	2	0.5	4	0.6	B
P ₀ :15.0	05	15.0	4.0	15.0	5.50	16	28	0.8	12	9	3	18	1	2	0.5	4	0.6	A
	08	15.0	5.0	15.0	5.00	16	30	0.8	12	9	3	18	1	2	0.5	4	0.6	A
	10	15.0	5.0	15.0	5.00	16	32	0.8	12	9	3	18	1	2	0.5	4	0.6	A
	13	15.0	7.5	30.0	3.75	16	35	0.8	12	9	3	18	1	2	0.5	4	0.6	C
	15	15.0	7.5	30.0	3.75	16	37	1.0	12	9	3	18	1	2	0.5	4	0.6	C
	20	15.0	7.5	30.0	3.75	16	42	1.0	12	9	3	18	1	2	0.5	4	0.6	C

NTC Thermistor : SCK Series

Power Thermistor for Limiting Inrush Current

■ Quantity

● Bulk Packing

Series	Standard Lead Type Quantity (pcs/bag)	Cut Lead Type Quantity (pcs/bag)	L kink Type Quantity (pcs/bag)
SCK05	250	500	---
SCK08	250	250	200
SCK10	200	250	200
SCK13	100	200	100
SCK15	100	100	100
SCK20	500 (pcs/box)	50	50
SCK25	168 (pcs/box)	168 (pcs/box)	---
SCK30	168 (pcs/box)	168 (pcs/box)	---

● Reel Packing

Series	D (mm)	D1 (mm)	W (mm)	Quantity (pcs/reel)
SCK05	340±10	31±1	55±1	2,500
SCK08				1,500
SCK10				1,500
SCK13				750
SCK15				750
SCK20				500

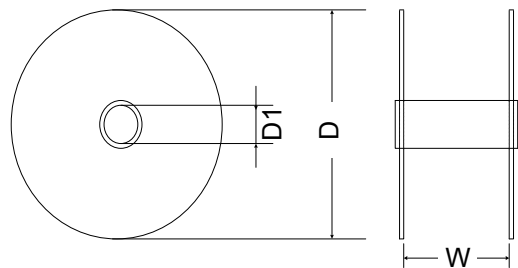

● Ammo Packing

Series	Quantity (pcs/box)
SCK05	1,000
SCK08	1,000
SCK10	1,000
SCK13	500
SCK15	500
SCK20	500

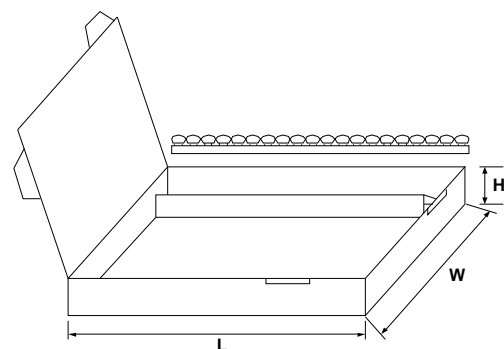

(Unit: mm)

Body Size	L	W	H
Φ5~Φ20	348	275	60

■ Warehouse Storage Conditions of Products

● Storage Conditions:

1. Storage Temperature: -10°C~+40°C
2. Relative Humidity: ≤75%RH
3. Keep away from corrosive atmosphere and sunlight.

● Period of Storage: 1 year